

HALFEN MT-FBC FLEXIBLE BOLT CONNECTIONS

Technical Product Information



Leviat

We imagine, model and make engineered products and innovative construction solutions that help turn architectural visions into reality and enable our construction partners to build better, safer, stronger and faster.

Leviat is a world leader in connecting, fixing, lifting and anchoring technology.

From the build of new schools, hospitals, homes and infrastructure, to the repair and maintenance of heritage structures, our engineering skills are making a difference around the world.

We provide technical design assistance at every stage of a project, from initial planning to installation and beyond.

Our technical support services range from simple product selection through to the development of a fully customised project-specific design solution.

Every promise we make locally, has the commitment and dedication of our global team behind it. We employ almost 3,000 people at 60 locations across North America, Europe and Asia-Pacific, providing an agile and responsive service worldwide.





>3,000
People

60+
Locations

~20
Countries

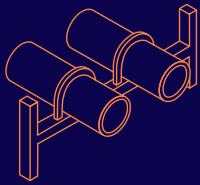

Industrial Technology

Mounting channels, pipe clamps and other versatile framing systems that provide safe fixing in a wide range of industrial applications.

- Modular Framing Systems
- Modular Support Systems
- Mounting Channel Systems
- Accessories for channels, framing & support systems
- General accessories
- Versatile Interior Systems

Other areas of expertise:

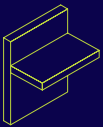

Structural Connections

Systems to form robust, efficient connections, and continuity of concrete reinforcement as necessary, between walls, slabs, columns, beams and balconies, providing structural integrity as well as enhanced thermal and acoustic performance.

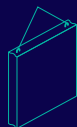

Lifting & Bracing

Systems for the safe and efficient transportation, lifting and temporary bracing of cast concrete elements and tilt-up panels before permanent structural connections are made.

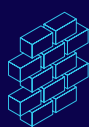

Façade Support & Restraint

Systems for the safe and thermally-efficient fixing of the external building envelope, including brick and natural stone, insulated sandwich panels, curtain walling and suspended concrete façades, and also the repair and strengthening of existing masonry installations.



Anchoring & Fixing

Systems for fixing secondary fixtures to concrete, including anchor channels, bolts and inserts; also tension rod systems for roofs and canopies.



Formwork & Site Accessories

Non-structural accessories that complement our engineered solutions and help keep your construction environment operating safely and efficiently, including moulds for casting standard and special concrete elements and construction essentials such as reinforcing bar spacers.

Leviat product ranges:

Ancon | Aschwanden | Connolly | Halfen | Helifix | Isedio | Meadow Burke | Modersohn | Moment | Plaka | Scaldex | Thermomass



© Fotolia

CONTENTS

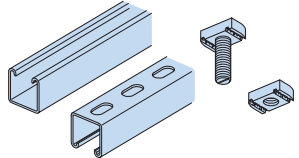
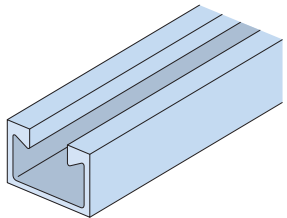
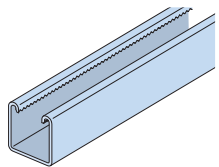
1 HALFEN Industrial Technology	Page 6	
General information	6-7	
2 Framing channels	Page 8	
Introduction – HALFEN Framing channels and HALFEN Bolts	8-9	
Bolt length selection, locking plates, order examples	10	
Framing channels – The advantages at a glance	11	
Materials, finishes, coatings	12-13	
Product range – overview framing channels and bolts	14-15	
3 Framing channels – heavy duty framing system	Page 16	
Profile HM 72/48	16	
HALFEN Bolt HS 72/48	17	
Profiles HM 55/42, HM 52/34	18-19	
Profiles HM 50/30, HM 49/30, HM 50/40, HM 486	20-22	
HALFEN Bolt HS 50/30, HSR 50/30	23	
Locking plates GWP 50/30, GWP 50/40	24	
Profiles HM 40/22, HM 40/25, HM 422	25-26	
HALFEN Bolts and locking plates HS 40/22, HSR 40/22, GWP 40/22	27	
Serrated profile HZM 64/44	28	
Serrated HALFEN Bolt HZS 64/44	29	
Serrated profile HZM 53/34	30	
Serrated HALFEN Bolt HZS 53/34	31	
Serrated profiles HZM 41/27, HZM 38/23	32-33	
HALFEN Bolts HZS 38/23, HS 38/17	34	
Serrated profile HZM 29/20	35	
HALFEN Bolts HZS 29/20, HS 28/15	36	
4 Framing channels – medium duty framing system	Page 37	
Profiles HM 41/41, HL 41/41	37	
Serrated profiles HZM 41/41, HZL 41/41	38	
Profiles HM 41/62, HL 41/62, HM 41/83, HL 41/83	39-40	
Powerclick standard profile HZL 63/63	41	
Profiles HM 41/22, HL 41/22	42	
Serrated profiles HZM 41/22, HZL 41/22	43	
HALFEN Bolts HZS 41/41, HZS 41/22, HS 41/41	44	
Locking plates GWP 41/... and locking plates with spring	45	

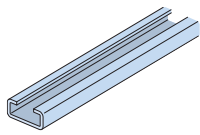
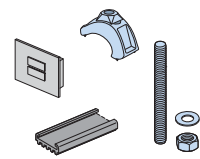
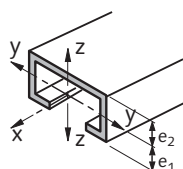
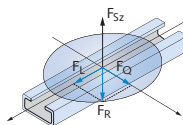

CONTENTS

5 Framing channels – light duty framing systems	Page 46	
Profiles HM 36/36, HL 36/36, HM 38/17	46	
HALFEN Bolts and locking plates HS 38/17, GWP 38/17	47	
Profiles 28/28, 28/15, HM 315	48–50	
HALFEN Bolts and locking plates 28/15	51	
Profiles and HALFEN Bolts 20/12	52–53	
6 Accessories	Page 54	
Channel end caps, channel covers	55	
HALFEN Bolts – overview	56–57	
Nuts, washers, connection parts	58–59	
Cantilevers – HALFEN Comprehensive adaptable support systems	60	
7 Statics	Page 62	
Cross section properties/bending load capacities: hot-rolled channels	62–63	
Cross section properties/bending load capacities: cold-rolled channels	64–65	
Cross section properties/bending load capacities: slotted channels	66–67	
Point load capacities, welded and dowel fixed framing channels	68–70	
Bending moment of HALFEN Bolts	71	
Flexural buckling – Framing channels as compression elements	72–73	
8 Applications in mechanical engineering	Page 74	
Design references	74	
Selecting the correct bolt length	75	
Channel-bolt connection: pre-tension load	77	
Channel-bolt connection: load capacities/design examples	78–80	
Transfer of dynamic loads	81	
Annex	Page 82	
Tender examples	82	
Powerclick System	83	
Index	84	
Contacts/technical support	87	

European Regulations

European Technical Assessment ETA

In 2019, a European Technical Assessment (abbreviated to ETA) for the HALFEN HM Framing channels was granted by the German Institute of Construction Engineering. The ETA was issued based on a technical specification document that includes the relevant assessment procedure. This specification document is defined as a European Assessment Document (abbreviated to EAD).



CPD 0432-CPR-00629
EAD 330667-00-0602

What is a CE marking?

The CE marking ensures that the responsibility for the conformity of the product with the performance stated in the declaration of performance (DoP), is assumed by the manufacturer and that all relevant European legislation is complied with.

European standards

Since its introduction in 2014, the EN 1090 series of standards has become firmly established in the market. The standard covers the design and manufacturing qualifications for steel structures. The European EN 1090-1 standard specifies requirements for proof of conformity for load-bearing steel components placed on the European market as construction products. The proof of conformity includes manufacturing details and if required load-bearing characteristics.

The EN 1090-2 standard specifies requirements for the design of steel structures. This standard applies to structures designed according to the corresponding section of EN 1993 (EC3). Basis of the conformity assessment for steel construction products is the conformity assessment procedure 2+ of the Construction Products Regulation EU No. 305/2011.

Our production is certified by the notified body ZDH ZERT GmbH. The certification not only covers production but also the design services provided by our engineers and their qualifications.



2499 – CPR-0113070-00-05

Design method

The European standard EN 1993 as well as the ETA were created with the intention to establish uniform, Europe-wide calculation methods for steel structures. However, because these calculation methods have not yet been adopted in all industries, we have decided to provide two tables of load capacities for the cantilever brackets.

- **working loads, referred to as allowable loads “allow F”.**
- **resistance design values, referred to as design values “F_{Rd}”.**

The term “design value” is taken from the current applicable standards, for example EN 1993 (EC3) and the European Technical Assessment, with their new safety concepts, and must be strictly differentiated from the term “allowable load”.

The European standard based on the method of “partial safety factors” is applied to material resistance as well as to the action (load).

The following verification is required:

$$F_{Ed} \leq F_{Rd}$$

F_{Ed} = calculation value for action
F_{Rd} = design value for resistance

The standard, deterministic safety concept however is based on the method of using a global safety factor for material resistance and is known as the “allowable load method” resp. “allowable tension method”. These methods are used in mechanical and plant engineering. For these cases the allowable values for load capacity are calculated.

Verification is as follows:

$$F \leq F_{allow}$$

F = load on the structure
allow F = allowable load

Benefits of HALFEN Framing channels

The versatile HALFEN Framing systems offer a wide range of benefits:

- The versatile HALFEN Channel-bolt system is a supporting as well as a fixing system
- Full flexibility in positioning and dimensioning bolt connections
- Selection of corrosion protection:
 - Strip galvanized framing channels for low demands
 - Hot-dip galvanized framing channels for high demands
 - Framing channels in stainless steel for maximum protection
- Quick assembly and adjustment of plant equipment and structural components
- Modify or update entire projects using only standard tools
- No specialist required to carry out on-site modifications
- Dust free and low noise levels when modification work is done on site
- Corrosion protection is not damaged by bolting
- A large selection of standard channels with excellent load bearing characteristics

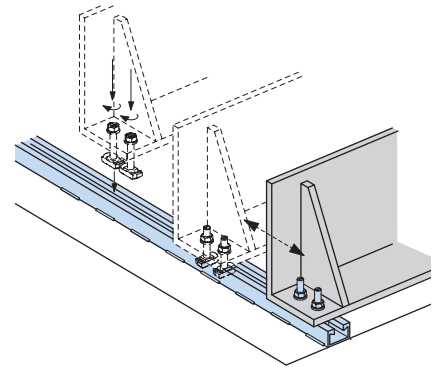

Avoid the following with HALFEN Framing channels:

- Time consuming planning of non-adjustable bolt fixings
- Costly manufacture of bolt fixings
- Costly corrosion protection work when upgrading already completed structural components i.e. when adjusting components "on-site"

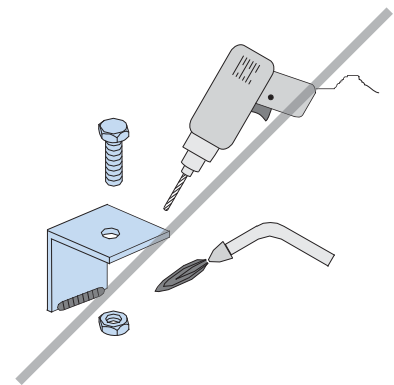

HALFEN Cast-in channels

All hot-rolled HALFEN Profiles and a number of the light framing channels are also available as **HALFEN HTA/HZA Cast-in channels**. Both versions use the same bolts and locking plates. You can find more information on HALFEN Channels in our Technical Product Information

More information about HALFEN Cast-in channels is available online at



www.halfen.com//product-ranges/construction/fixing-systems/

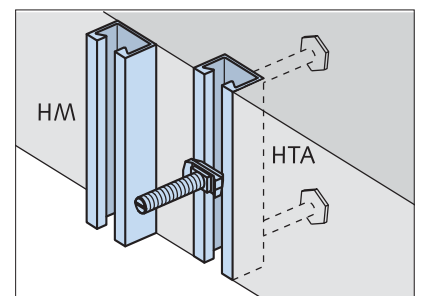

Quality Management

Quality is the outstanding feature of our products. All materials and products are subjected to the most stringent quality control.

A quality inspection by the DNV GL* has verified that our quality management system meets the requirements of the ISO 9001:2015 standard.



Certificate no. 202384-2016-AQ-GER-DAkkS

*merger of DNV (Det Norske Veritas) and GL (Germanischer Lloyd) in 2013

HALFEN INDUSTRIAL TECHNOLOGY

Framing channels

Framing channels HM, HL, HZM and HZL

Hot-rolled framing channels

The hot-rolling process makes these framing channels ideally suitable for:

- › heavy loads
- › dynamic loads
- › welding

Smooth HM Channels



- › very high tension load capacity
- › longitudinal loads are possible when using nibbed bolts (only applies to normal steel)

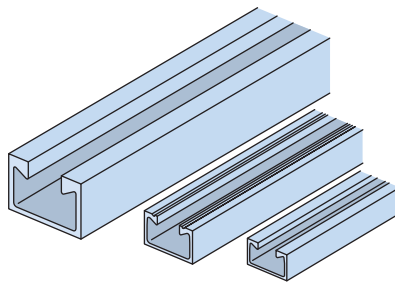

Roller-bearing fixing of a cableway

Serrated HZM Channels

- › serration allows high longitudinal loads
- › 5 channel sizes for maximum efficiency

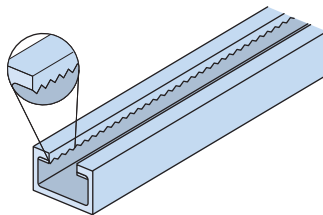

Welding-jig, locomotive construction

Cold-rolled framing channels

Cold-rolled channels are economic for lower loads. These channels are available slotted or non-slotted.

Smooth HL, HM Channels

- › economical due to large selection of channels

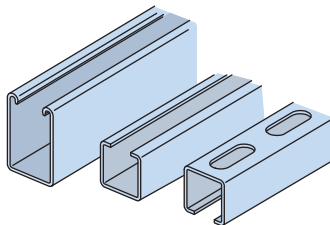

Serrated HZL, HZM Channels

- › for loads in longitudinal channel direction
- › positive-locking connection for high channel loads

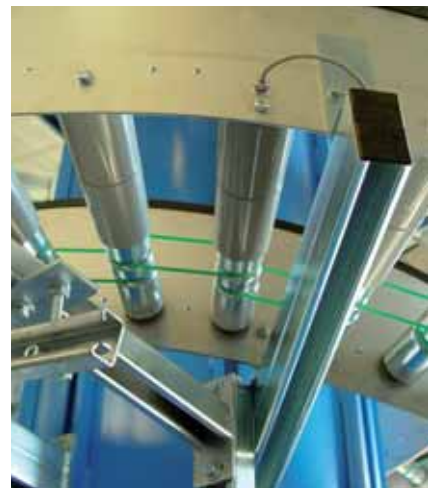
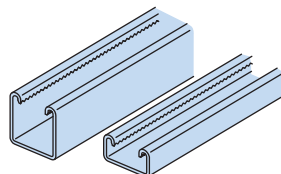

Cantilever fixings in a vertical conveyor system

HALFEN INDUSTRIAL TECHNOLOGY

Framing channels

HALFEN Bolts HS, HZS, HSR

Type HS

HALFEN Bolts

- > suitable for all channels
- > Load bearing capacity in two directions
- > marked at the bolt end with one notch

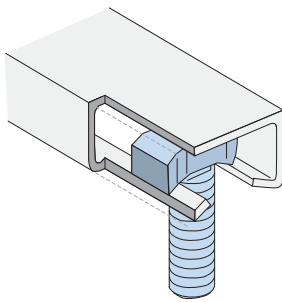

Type HSR

HALFEN Bolts with nibs

- > suitable for use in hot-rolled, normal steel channels from the heavy duty system
- > nibbed, positive-locked, load bearing in all directions
- > the hammer head design prevents the T-bolts turning under vibration
- > marked at the bolt end with two notches

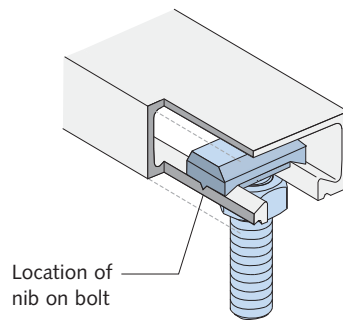

Type HZS

Serrated HALFEN Bolts

- > for serrated framing channels HZM and HZL
- > serration also provides positive-locked load transmission in longitudinal channel direction; no risk of slippage
- > marked at the bolt end with two notches

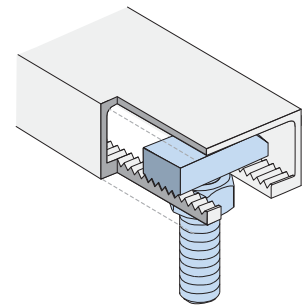

Identifying HALFEN Bolts

 Bolt identification on the bolt head

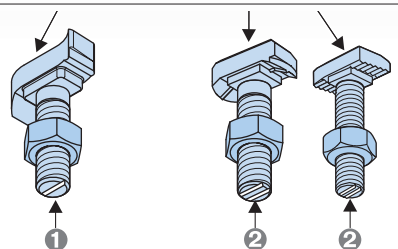

1

2

2

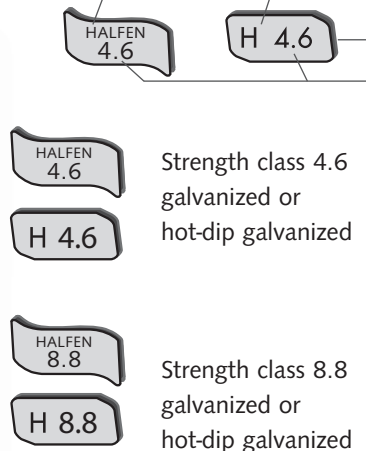

Manufacturer
(for individual dimension)
Strength class

Strength class 4.6 galvanized or hot-dip galvanized

Strength class 8.8 galvanized or hot-dip galvanized

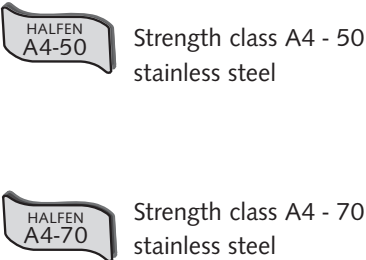

Strength class A4 - 50 stainless steel

Strength class A4 - 70 stainless steel

 Notches at the bolt end

HS All Types

HZS 41/22 

HSR All Types

HZS 38/23 

HZS 29/20 

Orientation notches: After assembly, check the correct orientation of the notches on the end of the bolts. The notches must be at right angles to the channel length.

HALFEN INDUSTRIAL TECHNOLOGY

Framing channels

Calculating the bolt length l_{req} for HALFEN Bolts (steel construction)

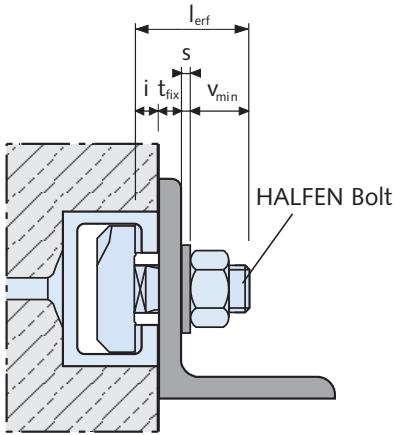

$$l_{req} = t_{fix} + i + s + v_{min}$$

l_{req} = required bolt length
 t_{fix} = thickness: attached component
 i = channel lip thickness
 s = washer thickness → see page 58

$v_{min} = m + u$
 m = nut height EN ISO 4032
 u = bolt protrusion approx. 5 mm according to DIN 78 (bolts larger M20 require min. 7 mm)

Dimensions v_{min}	
Bolt diameter	$v_{min} = m + u$ [mm]
M6	11.0
M8	12.5
M10	14.5
M12	17.0
M16	20.5
M20	26.0
M24	29.0
M27	31.5
M30	33.5

Thickness channel lip i

Channel	28/15	29/20	38/17	36/36	38/23	40/22	40/25	41/22	41/27	422	486	49/30	50/30	50/40	52/34	53/34	55/42	64/44	72/48
i [mm]	2.25	5.0	3.0	2.5	5.5	6.0	5.6	7.0	7.0	6.0	6.0	7.39	7.85	7.0	10.5	7.5	12.9	10.0	15.5

Locking plates GWP

Locking plates (channel nuts) allow any type of bolt with a metric thread to be used as well as threaded rods.

Locking plates with "grip" (see medium duty framing system, page 45). The "serration" grips the channel lips.

Locking plates with spring are used in particular for securing plates or panels (see medium duty framing system, page 45).

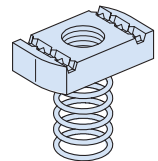
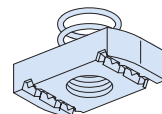
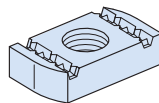
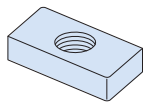
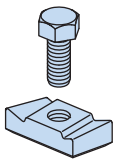

Ordering examples

Order example – framing channels

Type _____ **HM 50/30** _____ **FV-6070**
 Material _____
 Length (mm) _____

Order example – HALFEN Bolts

Type _____ **HS 50/30** _____ **M20 × 100** _____ **FV 8.8**
 Thread diam. _____
 Length (mm) _____
 Material _____
 Property class _____

or use the 12-digit order no. e.g. 0280.200-00003

or use the 12-digit order no. e.g. 0350.090-00129
Order numbers for HALFEN Bolts can be found in the HALFEN pricelist.

FRAMING CHANNELS

The advantages at a glance

Whether for low or very high loads: you will always find a cost effective solution for your requirements in the HALFEN product range of framing channels and bolts



Heavy duty framing system

The heavy duty framing channels are mostly hot-rolled and particularly suitable for heavy loads



Medium duty framing system

All medium duty framing channels have the same profile width, and are also compatible with the innovative HALFEN Powerclick system.

Versatile and adaptable

- › adjustable assembly
- › all connected elements remain adjustable. This allows easy replacement or upgrade of components as required
- › almost unlimited in its range of applications; in building projects, industrial projects, steel construction projects, engineering projects, vehicle manufacturing and many other areas

Safe and reliable

- › corrosion protection is not damaged by bolting
- › large selection of standard channels with optimal load bearing capacities
- › serrated channels for positive-lock connections







Light duty framing system

The light duty framing channel is the perfect fixing solution for low load applications.

HALFEN INDUSTRIAL TECHNOLOGY

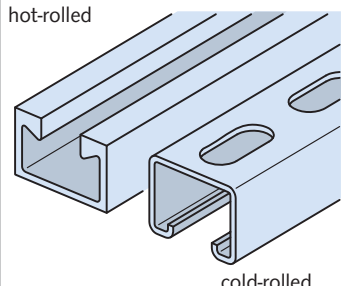
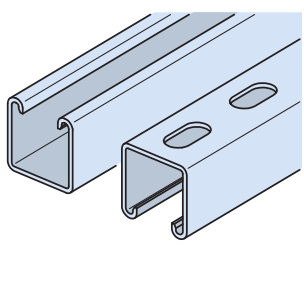
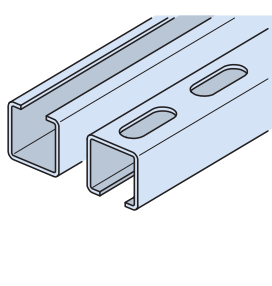
Materials, Types

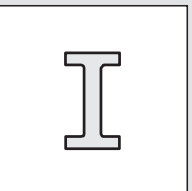
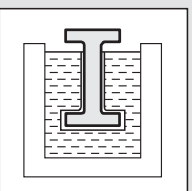
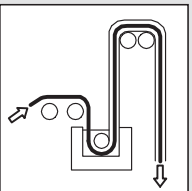
HALFEN Channels

HALFEN Channels		Heavy duty framing systems	Medium duty framing systems	Light duty framing systems
		 <p>hot-rolled cold-rolled</p> <p>Pages 16 – 36</p>	 <p>Pages 37 – 45</p>	 <p>Pages 46 – 53</p>
Material: Order code 				
 <p>Mill-finished</p>	WB Hot-rolled material S235JR, acc. to EN 10025, material no. 1.0038 Type HZM: S275JR, material no. 1.0044, acc. to EN 10025 Cold-rolled: material S235JR, acc. to EN 10025 mill-finished	Material S235JR, acc. to EN 10025, material no. 1.0038	Material S235JR, acc. to EN 10025, material no. 1.0038	
	 <p>Hot-dip galvanized acc. to EN ISO 1461 suitable for outdoor application</p>	FV Hot-rolled material S235JR, acc. to EN 10025, material no. 1.0038 type HZM: S275JR acc. to EN 10025 Cold-rolled: material S235JR, acc. to EN 10025 Hot-dip galvanized, acc. to EN ISO 1461, zinc coating min. 50 µm	Material S235JR, acc. to EN 10025, material no. 1.0038 Hot-dip galvanized, acc. to EN ISO 1461 zinc coating min. 50 µm	Material S235JR, acc. to EN 10025, material no. 1.0038 Hot-dip galvanized, acc. to EN ISO 1461, zinc coating min. 50 µm
 <p>Strip-galvanized acc. to EN 10142 suitable for indoor application</p>	SV	DX51D + Z275NA, material no. 1.0226, acc. to EN 10346 Sendzimir galvanized, hot-dip galvanized min. 20 µm	DX51D + Z275NA, material no. 1.0226, acc. to EN 10346 Sendzimir galvanized, hot-dip galvanized min. 20 µm	
 <p>Stainless steel acc. to EN 10088 and EN 1993-1-4</p>	A2		Material no. 1.4301, acc. to EN 10088	
	A4	Material no. 1.4571 / 1.4404, acc. to EN 10088	Material no. 1.4571 / 1.4404, acc. to EN 10088	
	HCR	HCR = high corrosion resistant stainless steel, material no. 1.4529 or 1.4547, acc. to EN 10088, for channels 49/30	HCR = high corrosion resistant stainless steel, material no. 1.4529 or 1.4547, acc. to EN 10088, for channels 28/15 and 38/17	

HALFEN INDUSTRIAL TECHNOLOGY

Materials, Types

HALFEN Bolts/Accessories

① HALFEN Bolts with s-shape head for safer assembly. The head shape guarantees better hold, preventing the bolt turning in the channel, even coping with manufacturing tolerances in the channel widths. HALFEN supplies both types; subject to change.

Material: Order code

HALFEN Bolts	Locking plates	Hexagon bolts	Hexagon nuts
<p>Types HS, HSR, HZS</p> <p>① Standard s-shaped head</p> <p>alternative shape of bolt head</p> <p>incl. nut</p> <p>Pages 56 – 57</p>	<p>Type GWP</p>	<p>Type HSK</p> <p>EN ISO 4017 DIN 933</p> <p>Page 59</p>	<p>Type MU</p> <p>DIN EN ISO 4032 DIN 934</p> <p>Page 58</p>

<p>Hot-dip galvanized acc. to EN ISO 10684, for threaded parts acc. to DIN 267 part 10</p>	FV 4.6	Hot-dip galvanized acc. to EN ISO 10684 strength class 4.6 acc. to EN ISO 898-1			
	FV 8.8	Hot-dip galvanized acc. to EN ISO 10684 strength class 8.8 acc. to EN ISO 898-1			Hot-dip galvanized acc. to EN ISO 10684 strength class 8
<p>Zinc-electroplated acc. to DIN 50961, DIN EN 1403, DIN EN ISO 4042</p> <p>zinc flake coating</p>	*GV 4.6	Zinc-electroplated with special coating Cr(VI)-free, GVs zinc coating min. 12 µm, strength class 4.6 acc. to EN ISO 898-1	Zinc-electroplated Cr(VI)-free, zinc cover min. 5 µm		
	*GV 8.8	Zinc-electroplated with special coating Cr(VI)-free, GVs zinc coating min. 12 µm, strength class 8.8 acc. to EN ISO 898-1		Zinc-electroplated Cr(VI)-free, zinc cover ca. 5 µm, strength class 8.8	Zinc-electroplated Cr(VI)-free, zinc cover min. 5 µm, strength class 8
	zl	Zinc flake coating (only Type HZS 41/41)			

*HS 40/22 and HS 50/30 bolts in grade GVs4.6 and GVs8.8 will be phased out in 2021 and will be replaced by grade FV4.6 and FV8.8 bolts (other GVs bolts listed in the bolt overview tables remain available).

<p>Stainless steel acc. to EN 10088 or EN 1993-1-4</p>	A2	Strength class 50 acc. to EN ISO 3506-1			Stainless steel A2	
		Strength class 70 acc. to EN ISO 3506-1				
	A4	Strength class 50 acc. to EN ISO 3506-1	Stainless steel A4		Stainless steel A4-70	Stainless steel A4-70 or A4-80
		Strength class 70 acc. to EN ISO 3506-1				
	HCR	Material HCR-50, material no. 1.4529, acc. to EN ISO 3506-1 on request				
	FA	Strength class 70 material no. 1.4462				

HALFEN INDUSTRIE-TECHNIK

Product Range Overview: Framing Channels and HALFEN Bolts

Heavy duty framing system						
Hot-rolled				Cold-rolled		
HM 72/48 NEW! CE European Technical Assessment ETA-19/0438 72 33 48,5	HM 55/42 NEW! CE European Technical Assessment ETA-19/0438 54,5 26 42	HM 52/34 NEW! CE European Technical Assessment ETA-19/0438 52,5 22,5 33,5	HM 50/30 NEW! CE European Technical Assessment ETA-19/0438 49 22,5 30	HM 49/30 50 22 30	HM 50/40, HL 50/40 49 22 39	HM 486 48 22 27
HS 72/48, HSR 72/48, GWP 72/48		HS 50/30	HS 50/30, HSR 50/30, GWP 50/30	HS 50/30, GWP 50/30 bzw. GWP 50/40		

Medium duty framing system					
Cold-rolled	Cold-rolled, serrated	Cold-rolled		Cold-rolled, serrated	
HM 41/41, HL 41/41 41 22 41	HZM 41/41, HZL 41/41 41 22 41	HM 41/62, HL 41/62 41 22 62	HM 41/83, HL 41/83 41 22 83	HZL 63/63 63 22 63	HZM 41/22, HZL 41/22 41 22 21
HZS/HS 41/41, HZS 41/22 GWP 41/41, GWP 41/22					

Light duty framing system					
Cold-rolled				Cold-rolled	
HM 36/36, HL 36/36 36 18 36	HM 38/17 38 18 17,5	HM 28/28, HL 28/28 28 12 28	HM 28/15, HL 28/15 28 12 15	HM 315 30 16 15	HM 20/12, HL 20/12 20 10 12
HS 38/17, GWP 38/17		HS 28/15, GWP 28/15		GWP 28/15	HS 20/12, GWP 20/12

HALFEN INDUSTRIE-TECHNIK

Product Range Overview: Framing Channels and HALFEN Bolts

Hot-rolled	Cold-rolled		Hot-rolled, serrated				
HM 40/22 ■ ■ ■	HM 40/25 ■ ■	HM 422 ■	HZM 64/44 ■ ■	HZM 53/34 ■ ■	HZM 41/27 ■	HZM 38/23 ■ ■	HZM 29/20 ■
NEW! 							
HS 40/22, HSR 40/22, GWP 40/22			HZS 64/44	HZS 53/34	HZS 38/23	HZS 38/23, HS 38/17	HZS 29/20, HS 28/15

Cold-rolled
HM 41/22, HL 41/22 ■ ■

Material and finishes:

- Sendzimir galvanized SV
- Hot-dip galvanized FV or mill finish WB
- Stainless steel A2 1.4301/1.4307
- Stainless steel A4 1.4571/1.4404
- Stainless steel HCR 1.4547/1.4529

Further information on materials and finishes → see page 12

HZM/HZL serrated profiles

Material grades: abbreviations

- A2:** Steel of corrosion resistance class (CRC) II according to EN 1993-1-4 : 2015-10, table A.3
- A4:** Steel of corrosion resistance class (CRC) III according to EN 1993-1-4 : 2015-10, table A.3
- HCR:** Steel of corrosion resistance class (CRC) V according to EN 1993-1-4 : 2015-10, table A.3

- 1 FRAMING CHANNELS
- 2 HEAVY DUTY FRAMING SYSTEMS
- 3 MEDIUM DUTY FRAMING SYSTEMS
- 4 LIGHT DUTY FRAMING SYSTEMS
- 5 ACCESSORIES
- 6 STATICS
- 7 MECHANICAL ENGINEERING

HALFEN INDUSTRIAL TECHNOLOGY

Framing Channels – Heavy Duty Framing System

Framing channel HM 72/48

HM 72/48 hot-rolled

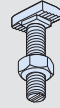

Suitable HALFEN Bolt HS 72/48 and HSR 72/48 → see page 17

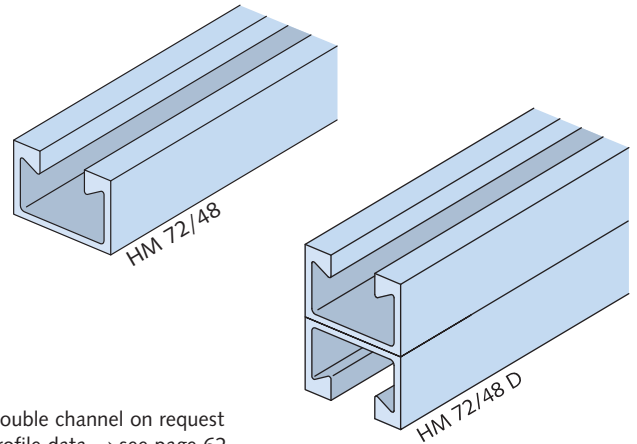
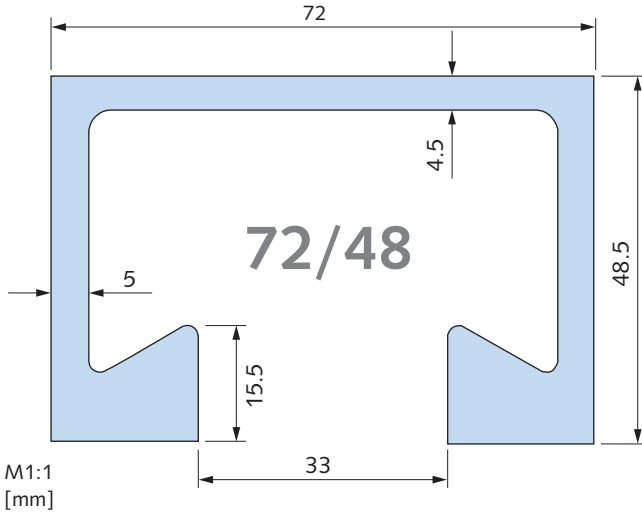

Double channel on request profile data, → see page 62

Dimensions and cross section properties									Load capacities				
Material	Order no.	Length	Weight	Cross section area	Moment of inertia		Section modulus		Max. point-load bearing capacity		Bending load capacity at span L		
		[mm]	[kg/m]	A [cm ²]	I _y [cm ⁴]	I _z [cm ⁴]	W _y [cm ³]	W _z [cm ³]	F _z ① [kN]	e _w [cm]	F [kN]		
HM 72/48	0280.								F _{z,Rd}		F _{Rd}		
WB	180-00002								66.7	30.0	31.2	15.6	10.4
FV	180-00003	6070	8.85	11.27	34.97	83.35	14.28	23.15	allow. F _z		allow. F		
A4	180-00001								47.6		22.3	11.2	7.4

① F_z = max. load bearing capacity of the channel lips – see also page 68

Accessories

VUS 72/49 Washer
→ see page 58

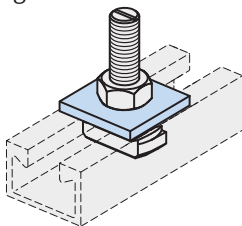

Further design properties

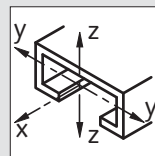

Cross section data
→ page 62

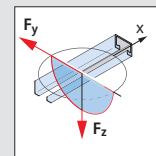

Point-load capacity
→ pages 62

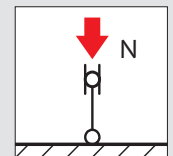

Flexural buckling
→ page 72

HALFEN INDUSTRIAL TECHNOLOGY

Framing Channels – Heavy Duty Framing System

HALFEN Bolts HS 72/48 and HSR 72/48

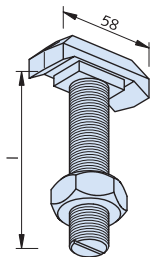

HS 72/48
HALFEN Bolt
incl. nut

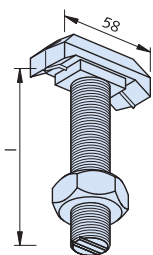

HSR 72/48
HALFEN Bolt with
nib incl. nut, for
hot-rolled channels
in mild steel WB/FV

HS 72/48 available bolts									
Length l [mm]	M20	M24	M27	M30	Length l [mm]	M20	M24	M27	M30
50	FV4.6	FV4.6 A4-50	-	-	100	FV4.6	FV4.6 A4-50	FV8.8	FV4.6
	FV8.8	-	-	-		FV4.6	FV4.6 GVs8.8	-	FV4.6
75	FV4.6	FV4.6	FV4.6	FV4.6	200	FV4.6	FV4.6	-	FV4.6
	GVs8.8	FV 8.8	-	-		FV4.6	FV4.6	-	FV4.6

HSR 72/48 available bolts	
Length l [mm]	M20
75	FV8.8

Load bearing capacities for HALFEN Bolts ①

Thread ϕ	Load capacities for HALFEN Bolts				Recommended load capacity per HALFEN Bolt in channel longitudinal direction				Recommended torque				
		F [kN] ①			HSR	F _x [kN]			HSR v = 3 ③	T _{inst} [Nm]			
		HS	HS	A4-50		HS ②	HSR v = 3 ③	HS		HSR			
72/48		4.6	8.8	A4-50	8.8	4.6	8.8	A4-50	8.8	4.6	8.8	A4-50	8.8
M20	F _{Rd}	35.2	78.4	-	78.4	1.96	6.58	-	10.5	130	360	-	400
	allow. F	25.1	56.0	-	56.0	1.4	4.7	-	7.5				
M24	F _{Rd}	50.7	113.0	44.5	-	2.8	9.52	2.8	-	250	620	200	-
	allow. F	36.2	80.7	31.8	-	2.0	6.8	2.0	-				
M27	F _{Rd}	66.0	146.9	-	-	3.64	12.46	-	-	340	900	-	-
	allow. F	47.1	104.9	-	-	2.6	8.9	-	-				
M30	F _{Rd}	80.6	-	-	-	4.48	15.26	-	-	460	1200	-	-
	allow. F	57.6	-	-	-	3.2	10.9	-	-				

① Note: do not exceed the max. channel load bearing capacity

② Load capability through friction

③ Acc. to expert report

Locking plates

Locking plate GWP 72/48

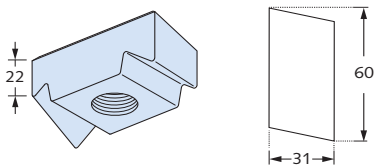

GWP 72/48 available locking plates				
GV thread	A4 thread	a [mm]	b [mm]	d [mm]
M12	M12	60	31	22
M16	M16			
M20	M20			

Load capacities GWP 72/48

Thread	Load capacity [kN]	
	F _{Rd}	allow. F
M12	F _{Rd}	13.0
	allow. F	9.3
M16	F _{Rd}	24.2
	allow. F	17.3
M20	F _{Rd}	30.8
	allow. F	22.0

HALFEN INDUSTRIAL TECHNOLOGY

Framing Channels – Heavy Duty Framing System

Framing channel HM 55/42

HM 55/42 hot-rolled

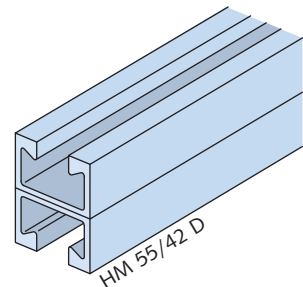
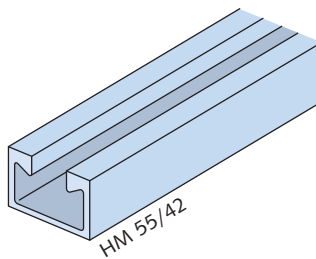
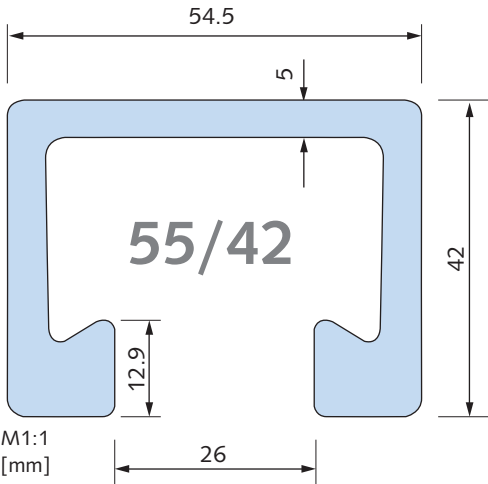
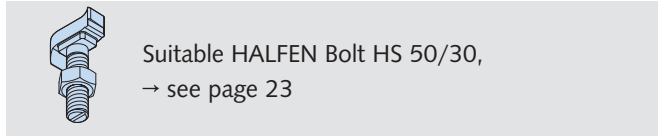

Double channel on request
profile data, -> see page 62

Dimensions and cross section properties								Load capacities						
Material	Order no.	Length [mm]	Weight G [kg/m]	Cross section area A [cm ²]	Moment of inertia I _y [cm ⁴] I _z [cm ⁴]		Section modulus W _y [cm ³] W _z [cm ³]		Max. point-load bearing capacity F _z [kN] e _w [cm]		Bending load capacity at span L F [kN] L [m]			
HM 55/42	0280.													
WB	290-00001	6070	6.76	8.6	18.75	36.29	8.49	13.32	F _{z,Rd}	25.0	F _{Rd}			
								55.6			23.5	11.7	7.8	
FV	290-00002								allow. F _z		allow. F			
									39.7		16.8	8.4	5.6	

① F_z = max. load bearing capacity of the channel lips - see also page 68

Accessories

VUS 72/49 Washer
-> see page 58

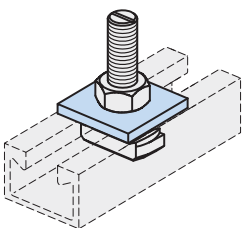

Further design properties

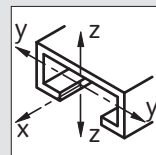

Cross section data
-> page 62

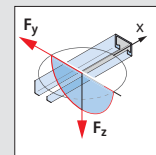

Point-load capacity
-> pages 68

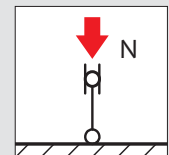

Flexural buckling
-> page 72

HALFEN INDUSTRIAL TECHNOLOGY

Framing Channels – Heavy Duty Framing System

Framing channel HM 52/34

HM 52/34 hot-rolled



Suitable HALFEN Bolts and locking plates
 HS 50/30, HSR 50/30, GWP 50/40 and
 GWP 50/30 → see pages 23–24

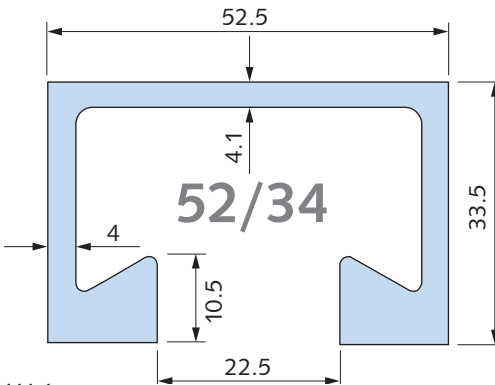

M1:1
[mm]

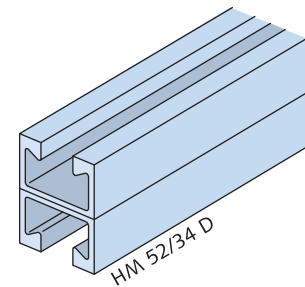
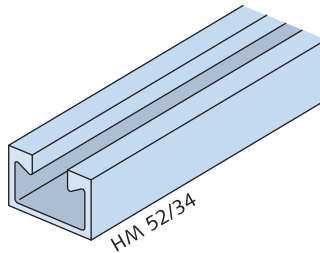

Double channel on request
 profile data → see page 62

Dimensions and cross section properties									Load capacities				
Material	Order no.	Length [mm]	Weight G [kg/m]	Cross section area A [cm ²]	Moment of inertia		Section modulus		Max. Point-load bearing capacity		Bending load capacity at span L		
					I_y [cm ⁴]	I_z [cm ⁴]	W_y [cm ³]	W_z [cm ³]	F_z ① [kN]	e_w [cm]	F [kN]		
HM 52/34	0280.												
WB	190-00002	6070	4.98	6.35	9.33	23.74	5.36	9.04	$F_{z,Rd}$	20.0	F_{Rd}		
FV	190-00003								37.8		12.3	6.1	3.9
A4	190-00001								allow. F_z		allow. F		
									27.0		8.8	4.4	2.8

① F_z = max. load bearing capacity of the channel lips – see also page 68

Accessories

VUS 52/34 Washer
 → see page 58

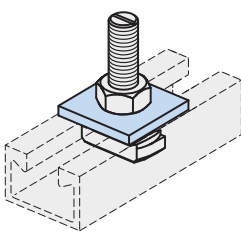

PA - 22 Channel cover
 → see page 55

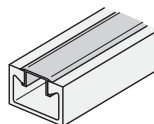

HPE 52/34 Channel end cap
 → see page 55

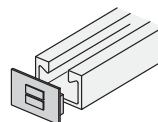

Further design properties

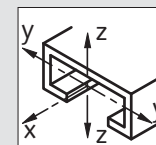

Cross section data
 → page 62

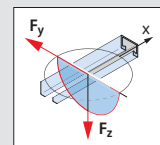

Point load capacity
 → page 68

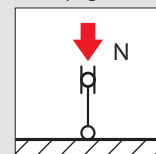

Flexural buckling
 → page 72

HALFEN INDUSTRIAL TECHNOLOGY

Framing Channels – Heavy Duty Framing System

Framing channel HM 50/30 and HM 49/30

HM 50/30 hot-rolled

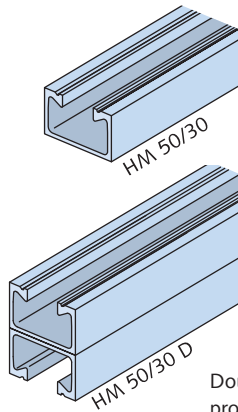
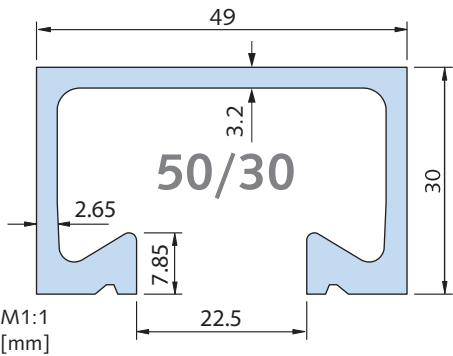

HM 49/30 cold-rolled

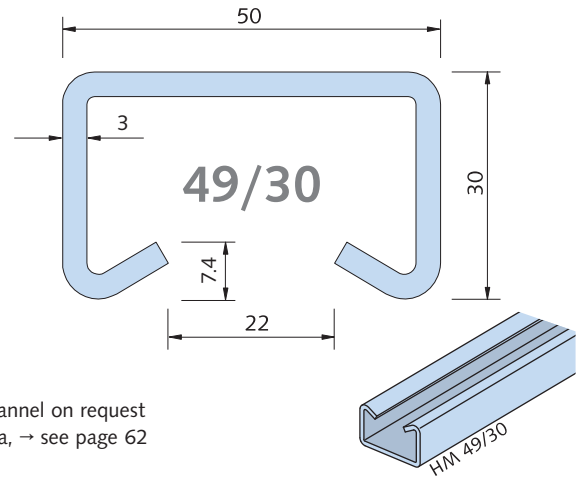

Double channel on request
profile data, → see page 62

Dimensions and cross section properties									Load capacities						
Material	Order no.	Length [mm]	Weight G [kg/m]	Cross section area A [cm ²]	Moment of inertia		Section modulus		Max. point-load bearing capacity		Bending load capacity at span L				
					I_y [cm ⁴]	I_z [cm ⁴]	W_y [cm ³]	W_z [cm ³]	F_z ① [kN]	e_w [cm]	0.5 m	1.0 m	1.5 m		
HM 50/30	0280.														
WB	200-00002								$F_{z,Rd}$			F_{Rd}			
FV	200-00003	6070	3.26	4.15	5.19	13.99	3.24	5.67	21.1	20	7.5	3.7	2.2		
A4	200-00001								allow. F_z		allow. F				
									15.1		5.3	2.7	1.6		
HM 49/30	0280.														
WB	220-00001								$F_{z,Rd}$			F_{Rd}			
FV	220-00002	6070	2.88	3.67	4.16	13.23	2.35	5.29	6.9	46	6.1	3.0	1.7		
A2 ②	220-00003								allow. F_z		allow. F				
A4	220-00004								4.9		4.3	2.2	1.2		

① F_z = max. load bearing capacity of the channel lips; ② Stainless steel A2 on request. Note: HCR for HM 49/30 on request

Accessories

VUS 52/34 Washer
→ see page 58

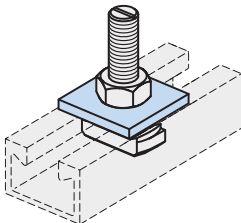

PA - 41 Channel cover
→ see page 55

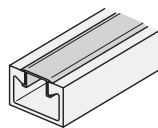

SIC 50/30 Locking washer
→ see page 58

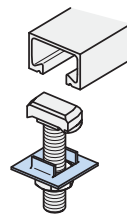

Suitable HALFEN Bolts and locking plates
HS 50/30, HSR 50/30 and
GWP 50/30 → see pages 23–24

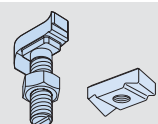

Further design properties

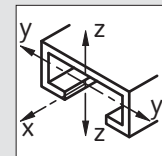

Cross section data →
→ pages 62, 64

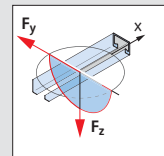

Point-load capacity
→ pages 68

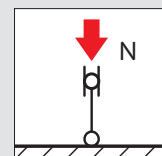

Flexural buckling
→ pages 72–73

HALFEN INDUSTRIAL TECHNOLOGY

Framing Channels – Heavy Duty Framing System

Framing channel HM and HL 50/40

HM 50/40 and HL 50/40 cold-rolled

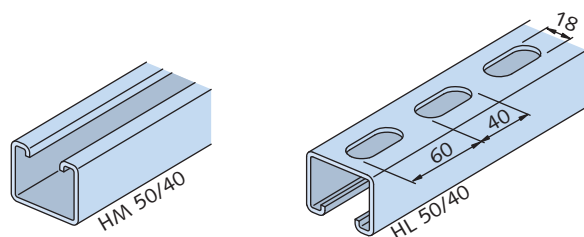
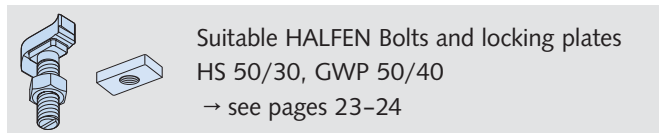
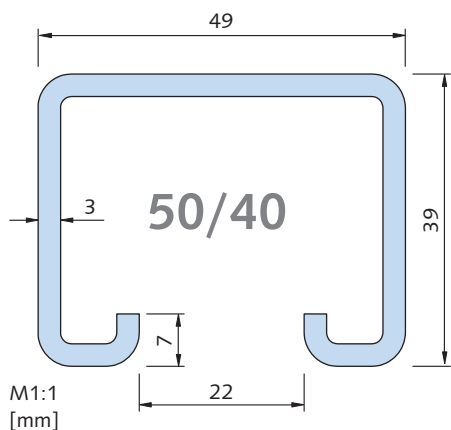

Dimensions and cross section properties									Load capacities				
Material	Order no.	Length [mm]	Weight G [kg/m]	Cross section area A [cm ²]	Moment of inertia [cm ⁴]		Section modulus [cm ³]		Max. point-load bearing capacity		Bending load capacity at span L		
					I_y	I_z	W_y	W_z	F_z ① [kN]	e_w [cm]	F [kN]		
											L [m]		
											0.5 m	1.0 m	1.5 m
HM 50/40	0280.	6000	3.35	4.26	8.64	15.49	3.96	6.32	$F_{z,Rd}$	63.0	F_{Rd}		
WB	090-00002								7.6		9.5	4.7	3.2
FV	090-00003								allow. F_z		allow. F		
A4	090-00001								5.4		6.8	3.4	2.3
HL 50/40	0281.	6000	3.15	3.73	7.14	15.36	3.65	6	$F_{z,Rd}$	53.0	F_{Rd}		
WB	100-00001								7.6		8.0	4.1	2.7
FV	100-00002								allow. F_z		allow. F		
A4	100-00003								5.4		5.7	2.9	1.9

① F_z = max. load bearing capacity of the channel lips

Accessories

HPE 50/40 Channel end cap
→ see page 55

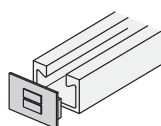

PA - 41 Channel cover
→ see page 55

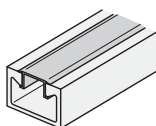

Further design properties

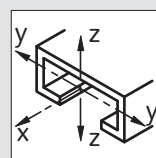

Cross section data
→ pages 64, 66

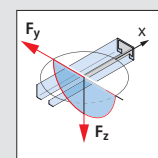

Point-load capacities
→ page 68

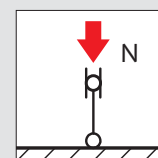

Flexural buckling
→ page 73

HALFEN INDUSTRIAL TECHNOLOGY

Framing Channels – Heavy Duty Framing System

Framing channel HM 486

HM 486 cold-rolled

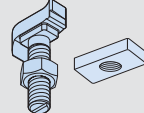

Suitable HALFEN Bolts and locking plates
HS 50/30 and GWP 50/40
→ see pages 22–23

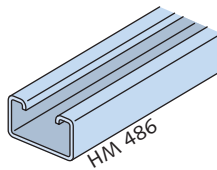
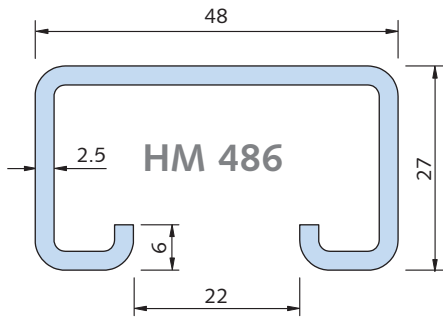

M1:1
[mm]

Dimensions and cross section properties									Load capacities						
Material	Order no.	Length [mm]	Weight G [kg/m]	Cross section area A [cm ²]	Moment of inertia		Section modulus		Max. point-load bearing capacity	Bending load capacity at span L					
					I_y [cm ⁴]	I_z [cm ⁴]	W_y [cm ³]	W_z [cm ³]	F_z ① [kN]	$\leq e_w$ [cm]	F [kN]				
HM 486	0280.														
WB	100-00001	6000	2.31	2.95	2.97	9.62	1.92	4.01	$F_{Rd,z}$	47.0	F_{Rd}				
									4.7		4.6	2.3	1.2		
FV	100-00002								allow. F_z		allow. F				
									3.5		3.3	1.7	0.9		

① F_z = load bearing capacity of the channel lips

Accessories

PA - 41 Channel cover
→ see page 55

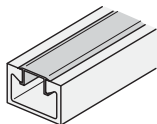

Further design properties

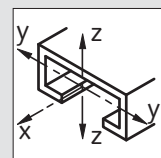

Cross section data
→ page 64

HALFEN INDUSTRIAL TECHNOLOGY

Framing Channels – Heavy Duty Framing System

HALFEN Bolts HS 50/30 and HSR 50/30

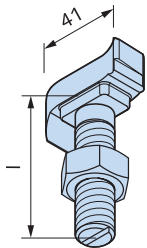

HS 50/30
HALFEN Bolt
incl. nut

T = partial thread

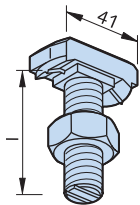

HSR 50/30
HALFEN Bolt with nib,
incl. nut, for hot-rolled
profiles in mild steel
WB/FV

HS 50/30 available bolts									
Length l [mm]	M10	M12	M16	M20	Length l [mm]	M10	M12	M16	M20
30	FV8.8	FV4.6 A4-70	-	-	75	-	-	-	FV4.6 A4-50 FA-70
40	FV8.8	FV4.6 FV8.8 A4-70	FV4.6 FV8.8 A4-50	-	80	-	FV4.6 FV8.8	FV4.6 FV8.8 A4-50 A4-70	FV4.6 FV8.8
45	-	FV8.8	-	FV4.6 FV8.8 A4-50	100	-	FV4.6 FV8.8 A4-50	FV4.6 FV8.8	FV4.6 FV8.8 A4-50 FA-70
50	FV8.8	FV4.6 FV8.8 A4-70	FV4.6 A4-70	-	100 T	-	-	A4-50	-
55	-	-	-	FV4.6 A4-50	125	-	FV4.6 FV8.8	-	FV4.6 FV8.8 A4-50
60	-	FV4.6 FV8.8	FV4.6 FV8.8 A4-50	FV8.8	150	-	GVs4.6	FV4.6	FV8.8 A4-50
65	-	-	-	FV4.6 FV8.8	175	-	-	FV8.8	-
70	-	FV8.8	-	-	200	-	GVs4.6	GVs4.6	GVs4.6
					300	-	-	GVs4.6	-



Grade GV4.6 and GV8.8 HS 50/30 bolts will be phased out in 2021 and will be replaced by grade FV 4.6 and FV 8.8 bolts (other GV bolts listed in the bolt overview tables remain available).

High corrosion resistant stainless steel HCR for HS 50/30 on request

HSR 50/30 available bolts									
Length l [mm]	M10	M12	M16	M20	Length l [mm]	M10	M12	M16	M20
40	-	-	FV8.8	-	75	-	-	-	GVs8.8
45	-	-	-	GVs8.8	80	-	-	FV8.8	-
60	-	-	FV8.8	GVs8.8	100	-	-	FV8.8	-

Load bearing capacities for HALFEN Bolts ①

Thread ϕ	Load capacities for HALFEN Bolts						Recommended load capacity per HALFEN Bolt in channel longitudinal direction					Recommended torque					
	F [kN]						F _x [kN]					T _{inst} [Nm]					
50/30	HS					HSR	HS ②				HSR ③	HS				HSR	
	4.6	8.8	A4-50	A4-70	FA-70	8.8	4.6	8.8	A4-50; A4-70	FA-70	8.8	4.6	8.8	A4-50	A4-70	FA-70	8.8
M10	F _{Rd}	8.3	17.2 (18.6)	-	-	-	0.42	1.54	-	-	-	15	40	-	-	-	-
	allow. F	5.9	12.2 (13.3)	-	-	-	0.3	1.1	-	-	-						
M12	F _{Rd}	12.1	27.0	10.6	22.7	-	0.7	2.24	0.7	-	-	25	70	25	-	-	-
	allow. F	8.6	19.3	7.6	16.2	-	0.5	1.6	0.5	-	-						
M16	F _{Rd}	22.6	50.2	19.8	42.2	-	1.26	4.2	1.26	-	7.0	65	180	60	130	-	200
	allow. F	16.1	35.9	14.1	30.2	-	0.9	3.0	0.9	-	5.0						
M20	F _{Rd}	35.2	78.4	30.9	-	66.0	78.4	1.96	1.96	1.96	10.5	130	360	120	-	250	400
	allow. F	25.1	56.0	22.1	-	47.1	56.0	1.4	1.4	1.4	7.5						
M24	F _{Rd}	50.7	-	-	-	-	2.8	9.5	-	-	-	230	-	-	-	-	-
	allow. F	36.2	-	-	-	-	2.0	6.8	-	-	-						

① Observe the channel load bearing capacity!

② Load capability through friction

③ acc. to expert report, $\nu = 3$

() only applies to GV's

HALFEN INDUSTRIAL TECHNOLOGY

Framing Channels – Heavy Duty Framing System

Locking plates GWP 50/30

Locking plate
GWP 50/30

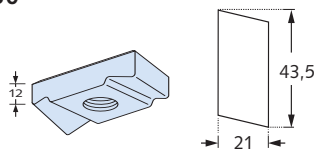

GWP 50/30 available bolts		
FV	GV	A4
-	M8	M8
M10	M10	M10
M12	M12	M12
M16	M16	M16

Load capacities for locking plates 50/30

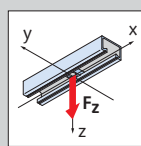

50/30

Thread	Load capacity [kN]	
	F_{Rd}	allow. F
M8	F_{Rd}	5.6
	allow. F	4.0
M10	F_{Rd}	9.0
	allow. F	6.4
M12	F_{Rd}	13.0
	allow. F	9.3
M16	F_{Rd}	13.0
	allow. F	9.3

Locking plates GWP 50/40

Locking plate
GWP 50/40

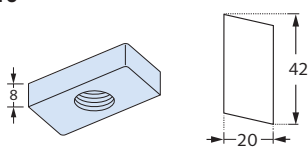

GWP 50/40 available bolts	
GV	A4
M6	M6
M8	M8
M10	M10
M12	M12
M16	M16

Load capacities for locking plates 50/40

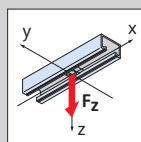

50/40

Thread	Load capacity [kN]	
	F_{Rd}	allow. F
M6	F_{Rd}	3.1
	allow. F	2.2
M8	F_{Rd}	5.6
	allow. F	4.0
M10	F_{Rd}	9.0
	allow. F	6.4
M12	F_{Rd}	9.0
	allow. F	6.4
M16	F_{Rd}	9.0
	allow. F	6.4

HALFEN INDUSTRIAL TECHNOLOGY

Framing Channels – Heavy Duty Framing System

Framing channel HM 40/22, HM 40/25

HM 40/22 hot-rolled

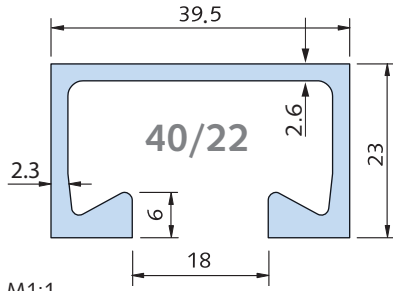

M1:1
[mm]

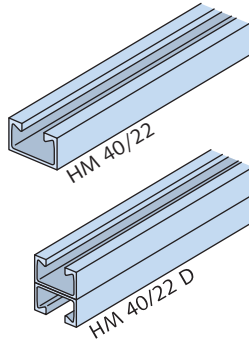

Double channel on request -
profile data, → see page 62

HM 40/25 cold-rolled

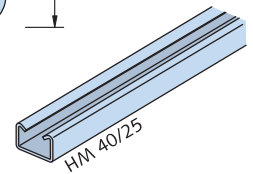
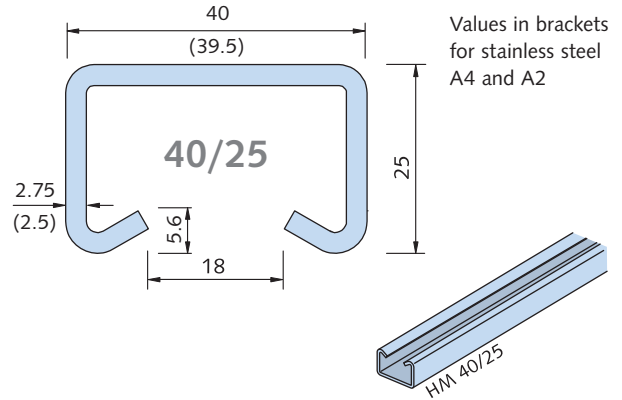

Dimensions and cross section properties									Load capacities				
Material	Order no.	Length [mm]	Weight G [kg/m]	Cross section area A [cm ²]	Moment of inertia		Section modulus		Max. point-load bearing capacity		Bending load capacity at span L		
					I_y [cm ⁴]	I_z [cm ⁴]	W_y [cm ³]	W_z [cm ³]	F_z ① [kN]	e_w [cm]	F [kN] L [m]		
											0.5 m	1.0 m	1.5 m
HM 40/22	0280.												
WB	210-00002	6070	2.12	2.70	1.98	5.77	1.59	2.92	$F_{z,Rd}$	15.0	F_{Rd}		
FV	210-00003								14.4		3.7	1.9	0.8
A4	210-00001								allow. F_z		allow. F		
									10.3		2.6	1.3	0.6
HM 40/25	0280.												
WB	230-00001	6070	2.09	2.66	2.05	6.09	1.39	3.05	$F_{z,Rd}$	33.0	F_{Rd}		
FV	230-00002								5.3		3.6	1.8	0.9
A2	230-00003								allow. F_z		allow. F		
A4	230-00004								3.8		2.6	1.3	0.6

① F_z = max. load bearing capacity for the channel lips – see also page 68

Accessories

VUS 40/25

Washer
→ see page 58

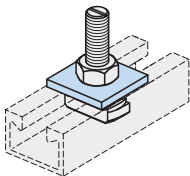

SIC 40/22

Locking washer
→ see page 58

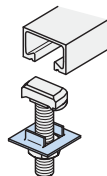

SDM - 36/6

Rubber vibration absorber
→ see catalogue MT-FFC

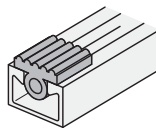

Suitable HALFEN Bolts and locking plates
HS 40/22, HSR 40/22 and
GWP 40/22 → see page 27

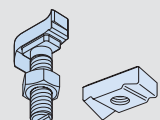

Further design properties

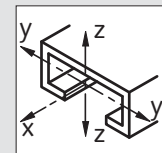

Cross section data
→ pages 62, 64

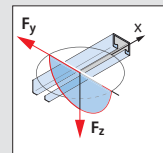

Point-load capacities
→ pages 68

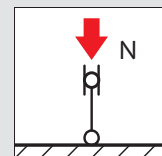

Flexural buckling
→ pages 72-73

HALFEN INDUSTRIAL TECHNOLOGY

Framing Channels – Heavy Duty Framing System

Framing channel HM 422

HM 422 (C40) cold-rolled

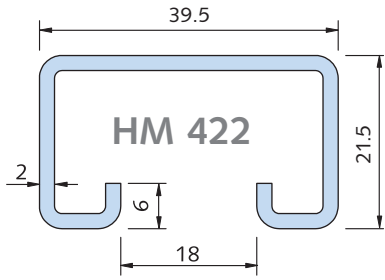

M1:1
[mm]

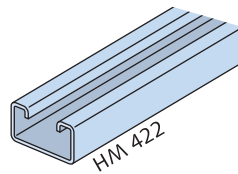

Suitable HALFEN Bolts and locking plates
HS 40/22 and GWP 40/22
→ see page 27

Dimensions and cross section properties									Load capacities				
Material	Order no.	Length	Weight	Cross section area	Moment of inertia		Section modulus		Max. point-load bearing capacity		Bending load capacity at span L		
		[mm]	G [kg/m]		I_y [cm ⁴]	I_z [cm ⁴]	W_y [cm ³]	W_z [cm ³]	F_z [kN]	e_w [cm]	F [kN]		
HM 422	0280.												
WB	110-00001	6000	1.55	1.98	1.27	4.29	1.04	2.17	F_z ①	≤ e_w	F_{Rd}		
FV	110-00002								3.5		2.5	1.2	
									allow. F_z		36.0	allow. F	0.5 m
									2.5		1.8	0.9	0.4

① F_z = max. load bearing capacity of the channel lips

Accessories

VUS 40/25
Washer
→ see page 58

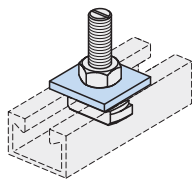

SIC 40/22
Locking washer
→ see page 58

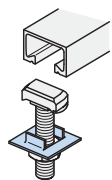

SDM - 36/6
Rubber vibration absorber
→ see catalogue MT-FFC

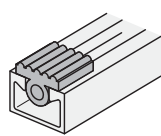

Further design properties

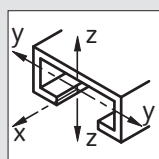

Cross section data
→ page 64

HALFEN INDUSTRIAL TECHNOLOGY

Framing Channels – Heavy Duty Framing System

HALFEN Bolts HS 40/22 and HSR 40/22

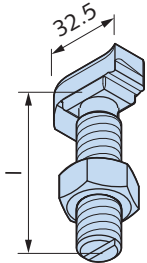

HS 40/22
HALFEN Bolt
incl. nut

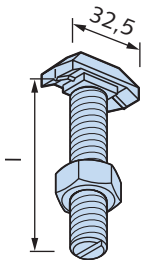

HSR 40/22
HALFEN Bolt with nib,
incl. nut, for hot-rolled
profiles in mild steel
WB/FV

HS 40/22 available bolts							
Length l [mm]	M10	M12	M16	Length l [mm]	M10	M12	M16
20	FV4.6	-	-	60	FV4.6	FV4.6	FV4.6
30	FV4.6	FV4.6	A4-50		FV8.8	FV8.8	FV8.8
	FV8.8	FV8.8		A4-70	A4-50	A4-50	A4-50
40	FV4.6	FV4.6	FV4.6	80	FV4.6	FV4.6	FV4.6
	FV8.8	FV8.8	FV8.8		FV8.8	FV8.8	FV8.8
45	-	FV8.8	-	100	FV4.6	FV4.6	FV4.6
	FV4.6	FV4.6	FV4.6		FV8.8	FV8.8	FV8.8
50	-	FV8.8	-	125	FV4.6	FV4.6	FV4.6
	FV4.6	FV4.6	FV4.6		-	GVs4.6	FV4.6
50	-	FV8.8	-	150	-	GVs4.6	GVs4.6
	FV4.6	FV4.6	FV4.6		-	GVs4.6	GVs4.6
50	-	FV8.8	-	200	-	GVs4.6	GVs4.6
	FV4.6	FV4.6	FV4.6		-	GVs4.6	GVs4.6
50	-	FV8.8	-	250	-	-	GVs4.6
	FV4.6	FV4.6	FV4.6		-	-	GVs4.6
50	-	FV8.8	-	300	-	-	GVs4.6
	FV4.6	FV4.6	FV4.6		-	-	GVs4.6

! Grade GV4.6 and GV8.8 HS 40/22 bolts will be phased out in 2021 and will be replaced by grade FV4.6 and FV8.8 bolts (other GV bolts listed in the bolt overview tables remain available).

HSR 40/22 available bolts			
Length l [mm]	M10	M12	M16
40	-	-	GVs8.8
60	-	-	FV8.8

Load bearing capacities for HALFEN Bolts ①

Thread ϕ	Load capacities for HALFEN Bolts						Recommended load capacity per HALFEN Bolt in channel longitudinal direction ②					Recommended torque				
		HS				HSR	HS				HSR ③	HS				HSR
		4.6	8.8	A4-50	A4-70	8.8	4.6	8.8	A4-50	A4-70	8.8	4.6	8.8	A4-50	A4-70	8.8
40/22	F_{Rd}	8.3	17.2 (18.6)	-	15.6	-	-	-	0.42	-	15	-	-	30	-	
	allow. F	5.9	12.2 (13.3)	-	11.2	-	0.3	-	0.3	-	25	70	25	-	70	
M10	F_{Rd}	12.1	27.0	10.6	-	-	-	0.7	-	-	65	180	60	130	200	
	allow. F	8.6	19.3	7.6	-	-	0.5	1.6	0.5	-	5.0	150	50	100	150	
M12	F_{Rd}	22.6	50.2	19.8	42.2	50.2	-	-	1.26	1.26	7.0	180	180	180	200	
	allow. F	16.1	35.9	14.1	30.2	39.9	0.9	3.0	0.9	0.9	5.0	150	150	150	150	

① Note: do not exceed the channel load bearing capacity ② Load capability through friction ③ acc. to expert report, $v = 3$ () only applies to GVs

Locking plates GWP 40/22

Locking plate
GWP 40/22

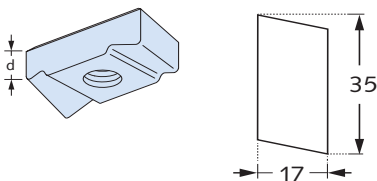

GWP 40/22 available plates				
GV	A4	a [mm]	b [mm]	d [mm]
M5	-	35	17	10
M6	-			
M8	M8			
M10	M10			
M12	M12			11.5

Load capacities for GWP 40/22

40/22	Thread	Load capacity [kN]	
		F_{Rd}	allow. F
	M5	F_{Rd}	3.1
		allow. F	2.2
	M6	F_{Rd}	3.1
		allow. F	2.2
	M8	F_{Rd}	5.6
		allow. F	4.0
	M10	F_{Rd}	9.0
		allow. F	6.4
	M12	F_{Rd}	13.0
		allow. F	9.3

HALFEN INDUSTRIAL TECHNOLOGY

Framing Channels – Heavy Duty Framing System

Framing channel HZM 64/44

HZM 64/44 hot-rolled, serrated 

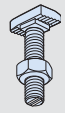

Suitable HALFEN Bolts
HZS 64/44 → see page 29

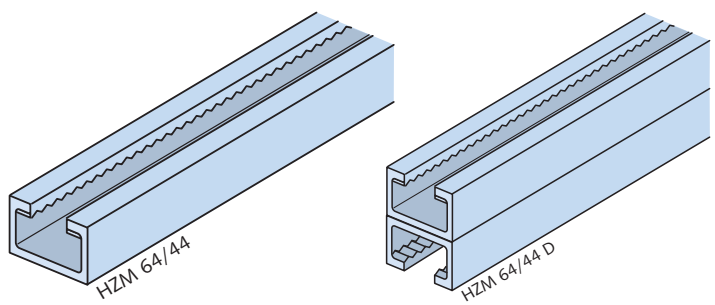
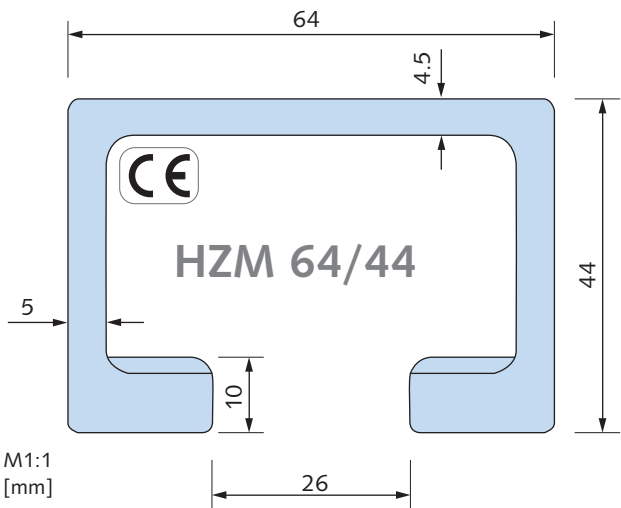

Double channel on request
profile data, → see page 62

Dimensions and cross section properties									Load capacities				
Material	Order no.	Length [mm]	Weight G [kg/m]	Cross section area A [cm ²]	Moment of inertia		Section modulus		Max. point-load bearing capacity		Bending load capacity at span L		
					I_y [cm ⁴]	I_z [cm ⁴]	W_y [cm ³]	W_z [cm ³]	F_z ① [kN]	$\leq e_w$ [cm]	F [kN]		
HZM 64/44	0284.	6070	7.15	9.1	23.83	53.94	10.36	16.85	53.3	25.0	0.5 m	1.0 m	1.5 m
WB	080-00002										F _{Rd}		
FV	080-00003										34.8	17.4	10.0
A4	080-00001										allow. F		
									38.1		24.8	12.4	7.1

① F_z = max. load bearing capacity of the channel lips – see also page 69

Accessories

VUS 72/48
Washer
→ see page 58

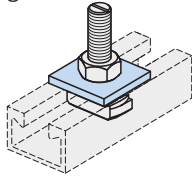

Further design properties

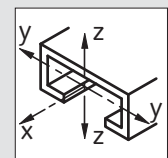

Cross section data
→ page 62

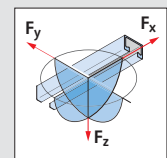

Point-load capacities
→ pages 69

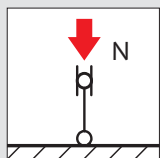

Flexural buckling
→ page 72

HALFEN INDUSTRIAL TECHNOLOGY

Framing Channels – Heavy Duty Framing System

HALFEN Bolts HZS 64/44

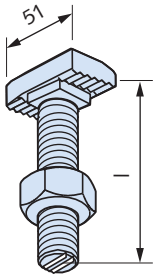

HZS 64/44
HALFEN Bolt,
serrated
incl. nut

HZS 64/44 available bolts		
Length l [mm]	M20	M24
80	FV8.8 A4-70	GVs8.8 A4-70 ①
125	GVs8.8 A4-70	-
150	-	GVs8.8 A4-70

① On request

Load bearing capacities for HALFEN Bolts ①

Thread \varnothing	Load capacities for HALFEN Bolts		Max. load capacity per HALFEN Bolt in channel longitudinal direction		Recommended torque		
	 F [kN] ①		 F _x [kN] ①		 T _{inst} [Nm]		
64/44	HZS		HZS		HZS		
		8.8	A4-70	8.8	A4-70	8.8	A4-70
M20	F _{Rd}	79.0	51.5	37.8	37.8	350	350
	allow. F	56.4	36.8	27.0	27.0		
M24	F _{Rd}	113.7	54.3	37.8	37.8	450	450
	allow. F	81.2	38.8	27.0	27.0		

① Note: do not exceed the max. channel load bearing capacity

In case of simultaneous loading in all directions (longitudinal -x, transverse -y, central tension -z) the resultant load must not exceed the load bearing capacity given in the table.

$$\sqrt{F_x^2 + F_y^2 + F_z^2} \leq \text{allow. F}$$

resp.

$$\sqrt{F_{x,Ed}^2 + F_{y,Ed}^2 + F_{z,Ed}^2} \leq F_{Rd}$$

F_x, F_y, F_z = existing loads
allow. F = allowable load bearing capacity of the bolt

resp.

F_{x,Ed}, F_{y,Ed}, F_{z,Ed} = design values of action

F_{Rd} = design value of resistance

HALFEN INDUSTRIAL TECHNOLOGY

Framing Channels – Heavy Duty Framing System

Framing channel HZM 53/34

HZM 53/34 hot-rolled, serrated 

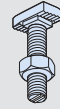

Suitable HALFEN Bolts HZS 53/34
→ see page 31

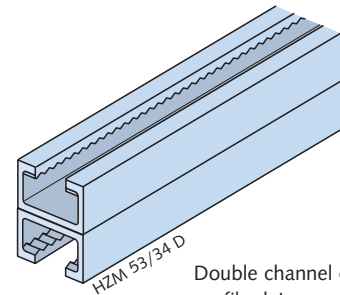
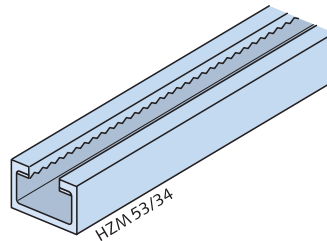
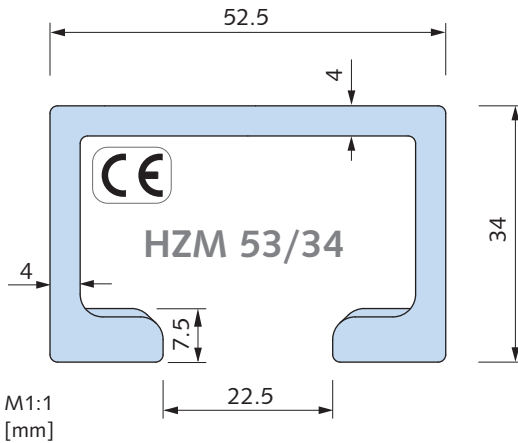

Double channel on request
profile data, → see page 62

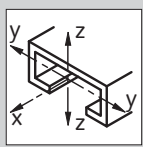
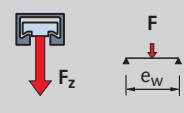
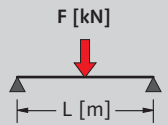
Dimensions and cross section properties									Load capacities				
Material	Order no.	Length [mm]	Weight G [kg/m]	Cross section area A [cm ²]	Moment of inertia 		Section modulus W _y [cm ³]		Max. point-load bearing capacity 		Bending load capacity at span L 		
HZM 53/34	0284.				I _y [cm ⁴]	I _z [cm ⁴]	W _y [cm ³]	W _z [cm ³]	F _z ① [kN]	≤ e _w [cm]	0.5 m	1.0 m	1.5 m
WB	070-00002	6070	4.63	5.88	9.19	23.18	4.95	8.83	F _{z,Rd}	20.0	F _{Rd}		
FV	070-00003								43.3		17.3	8.6	3.8
A4	070-00001								allow. F _z		allow. F		
									30.9		12.4	6.2	2.7

① F_z = max. load bearing capacity of the channel lips – see also page 69

Accessories

VUS 52/34
Washer
→ see page 58

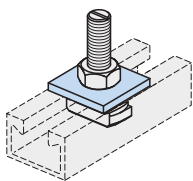

PA - 22
Channel cover
→ see page 55

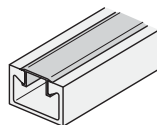

Further design properties

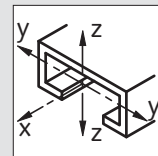

Cross section data
→ page 62

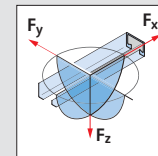

Point-load capacities
→ pages 69

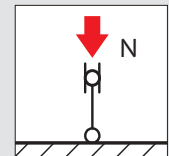

Flexural buckling
→ page 72

HALFEN INDUSTRIAL TECHNOLOGY

Framing Channels – Heavy Duty Framing System

HALFEN Bolts HZS 53/34

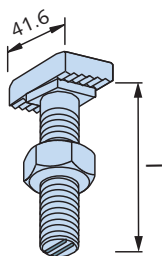

HZS 53/34
HALFEN Bolt,
serrated
incl. nut

HZS 53/34 available bolts		
Length l [mm]	M16	M20
60	FV8.8 A4-70	-
65	-	FV8.8 A4-70
100	FV8.8 A4-70	GVs8.8 A4-70

Load bearing capacities for HALFEN Bolts ①

Thread Ø	Load capacities for HALFEN Bolts		Max. load capacity per bolt in channel longitudinal direction		Recommended torque		
	F [kN] ①		F _x [kN] ①		T _{inst} [Nm]		
53/34	HZS		HZS		HZS		
		8.8	A4-70	8.8	A4-70	8.8	A4-70
M16	F _{Rd}	50.5	33.0	30.8	26.6	200	200
	allow. F	36.1	23.6	22.0	19.0		
M20	F _{Rd}	79.0	51.5	30.8	26.6	350	350
	allow. F	56.4	36.8	22.0	19.0		

① Note: do not exceed the max. channel load bearing capacity

In case of simultaneous loading in all directions (longitudinal -x, transverse -y, central tension -z) the resultant load must not exceed the load bearing capacity given in the table.



$$\sqrt{F_x^2 + F_y^2 + F_z^2} \leq \text{allow. F}$$

resp.

$$\sqrt{F_{x,Ed}^2 + F_{y,Ed}^2 + F_{z,Ed}^2} \leq F_{Rd}$$

F_x, F_y, F_z = existing loads
allow. F = allowable load bearing capacity of the bolt

resp.

F_{x,Ed}, F_{y,Ed}, F_{z,Ed} = design values of action

F_{Rd} = design value of resistance

HALFEN INDUSTRIAL TECHNOLOGY

Framing Channels – Heavy Duty Framing System

Framing channel HZM 41/27

HZM 41/27 hot-rolled, serrated 

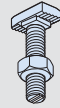

Suitable HALFEN Bolts HZS 38/23
→ see page 34

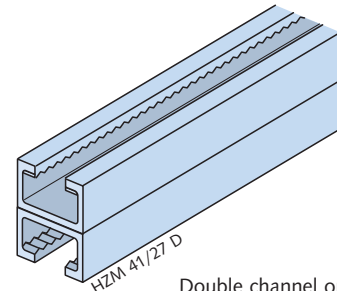
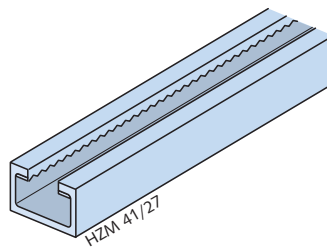
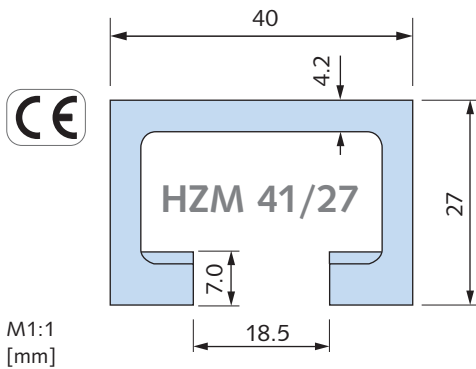

Double channel on request
profile data, → see page 62

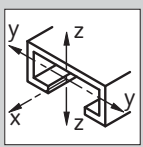
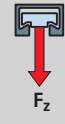
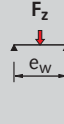
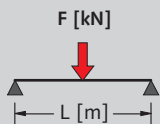
Dimensions and cross section properties									Load capacities				
		Length	Weight	Cross section area	Moment of inertia		Section modulus		Max. point-load bearing capacity		Bending load capacity at span L		
													
Material	Order no.	[mm]	G [kg/m]	A [cm ²]	I _y [cm ⁴]	I _z [cm ⁴]	W _y [cm ³]	W _z [cm ³]	F _z ① [kN]	≤ e _w [cm]	0.5 m	1.0 m	1.5 m
HZM 41/27	0284.								F _{z,Rd}		F _{Rd}		
WB	090-00002	6070	3.38	4.31	3.90	9.49	2.57	4.75	25.0	20.0	9.5	3.7	1.6
FV	090-00001								allow. F _z		allow. F		
									17.8		6.8	2.6	1.2

① F_z = max. load bearing capacity of the channel lips – see also page 69

Accessories

VUS 40/25
Washer
→ see page 58

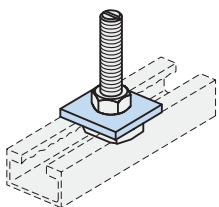

SIC 38/23
Locking washer
→ see page 58

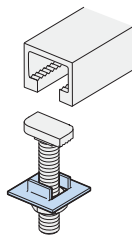

Further design properties

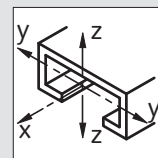

Cross section data
→ page 62

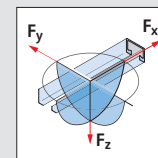

Point-load capacities
→ pages 69

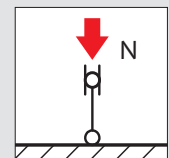

Flexural buckling
→ page 72

SDM - 36/6
Rubber vibration absorber
→ see MT-FFC catalogue

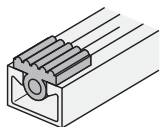

HALFEN INDUSTRIAL TECHNOLOGY

Framing Channels – Heavy Duty Framing System

Framing channel HZM 38/23

HZM 38/23 hot-rolled, serrated 

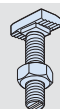

Suitable HALFEN Bolts HZS 38/23 and HS 38/17 → see page 34

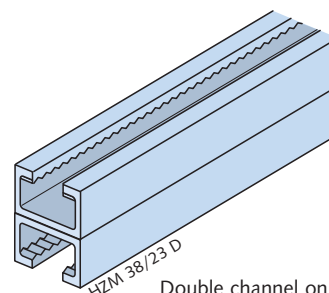
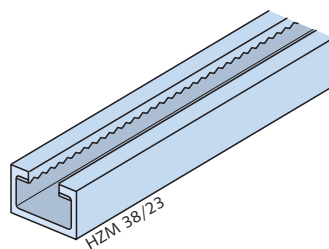
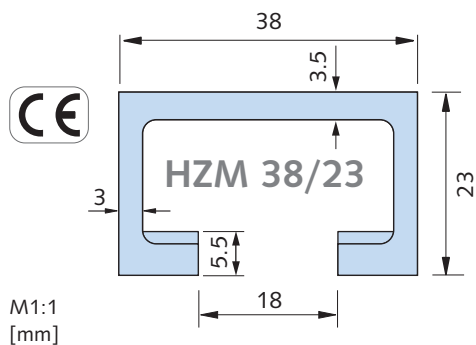

Double channel on request
profile data, → see page 62

Dimensions and cross section properties									Load capacities				
Material	Order no.	Length	Weight	Cross section area	Moment of inertia		Section modulus		Max. point-load bearing capacity		Bending load capacity at span L		
		[mm]	[kg/m]	[cm ²]	I_y	I_z	W_y	W_z	F_z	$\leq e_w$	F [kN]		
					[cm ⁴]	[cm ⁴]	[cm ³]	[cm ³]	[kN]	[cm]	0.5 m	1.0 m	1.5 m
HZM 38/23	0284.								$F_{z,Rd}$	20	F_{Rd}		
WB	060-00001								18.0		5.9	2.0	0.9
FV	060-00003	6070	2.43	3.09	2.11	6.17	1.59	3.25	allow. F_z		allow. F		
A4	060-00002								12.8		4.2	1.4	0.6

① F_z = max. load bearing capacity of the channel lips – see also page 69

Accessories

VUS 40/25

Washer
→ see page 58

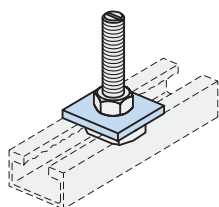

SIC 38/23

Locking washer
→ see page 58

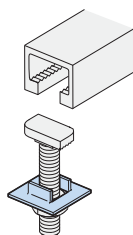

SDM - 36/6

Rubber vibration absorber
→ see MT-FFC catalogue

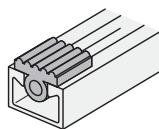

Further design properties

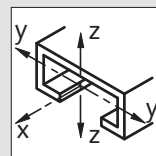

Cross section data
→ page 62

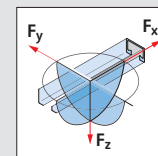

Point-load capacities
→ pages 69

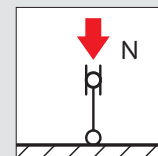

Flexural buckling
→ page 72

HALFEN INDUSTRIAL TECHNOLOGY

Framing Channels – Heavy Duty Framing System

HALFEN Bolts HZS 38/23 and HS 38/17

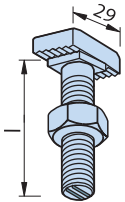

HZS 38/23
HALFEN Bolt
serrated incl. nut

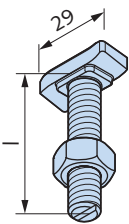

HS 38/17
HALFEN Bolt
incl. nut

i On request
HCR High corrosion resistant stainless steel for HS 38/17

HZS 38/23 available bolts					
Length l [mm]	M12	M16	Length l [mm]	M12	M16
30	GVs8.8	GVs8.8	100	GVs8.8	GVs8.8
40	GVs8.8	GVs8.8	125	GVs8.8	GVs8.8
50	GVs8.8	GVs8.8	150	GVs8.8	GVs8.8
60	GVs8.8	GVs8.8 A4-70	200	-	GVs8.8
80	GVs8.8	GVs8.8 A4-70	300	-	GVs8.8

HS 38/17 available bolts							
Length l [mm]	M10	M12	M16	Length l [mm]	M10	M12	M16
20	GVs4.6	GVs4.6	-	60	GVs4.6 A4-70	GVs4.6 GVs8.8 A2-70 A4-70	GVs4.6 FV8.8
25	-	A4-70	-		70	-	FV8.8
30	GVs4.6 FV 4.6 A4-70	GVs4.6 FV4.6 A2-70 A4-70	GVs4.6 FV4.6 A4-50	80		GVs4.6	GVs4.6 A4-70
	40	GVs4.6 A4-70	GVs4.6 FV4.6 A2-70 A4-70		100	GVs4.6	GVs4.6 A4-50
50	GVs4.6 FV4.6 A4-70	GVs4.6 FV4.6 A2-70 A4-70	GVs4.6 FV4.6 A4-50 A4-70	125	-	GVs4.6	GVs4.6
				150	GVs4.6	GVs4.6	GVs4.6 A4-50
				200	-	GVs4.6	GVs4.6

① on request

Load bearing capacities for HALFEN Bolts ①

Thread ϕ	Load capacities for HALFEN Bolts				Max. load capacity per bolt in channel longitudinal direction		Recommended torque						
	F [kN] ①		F _x [kN] ①		T _{inst} [Nm]								
38/23	HZS				HZS		HZS						
	8.8		A4-70		For all strength classes		8.8		A4-70				
	F _{Rd}	27.2	-	-	16.8	80	-						
	allow. F	19.4	-	-	12.0	120	120						
M12	F _{Rd}	50.5	33.0	-	16.8								
	allow. F	36.1	23.6	-	12.0								
	HS				HS		HS						
		4.6	8.8	A2-50; A4-50	A2-70; A4-70	-	4.6	8.8	A2-50; A4-50	A2-70; A4-70			
M10	F _{Rd}	8.3	18.6	7.3	15.6	HALFEN Bolts HS are not suitable for longitudinal loads in serrated channels!							
	allow. F	5.9	13.3	5.2	11.2								
M12	F _{Rd}	12.1	27.0	10.6	22.7					15	40	15	30
	allow. F	8.6	19.3	7.6	16.2					25	70	25	50
M16	F _{Rd}	22.6	50.2	19.8	42.2	65	180	60	130				
	allow. F	16.1	35.9	14.1	30.2								

① Note: do not exceed the max. channel load bearing capacity

In case of simultaneous loading in all directions (longitudinal -x, transverse -y, central tension -z) the resultant load must not exceed the load bearing capacity given in the table.



$$\sqrt{F_x^2 + F_y^2 + F_z^2} \leq \text{allow. F}$$

resp.

$$\sqrt{F_{x,Ed}^2 + F_{y,Ed}^2 + F_{z,Ed}^2} \leq F_{Rd}$$

F_x, F_y, F_z = existing loads
allow. F = allowable load bearing capacity of the bolt

resp.
F_{x,Ed}, F_{y,Ed}, F_{z,Ed} = design values of action
F_{Rd} = design value of resistance

HALFEN INDUSTRIAL TECHNOLOGY

Framing Channels – Heavy Duty Framing System

Framing channel HZM 29/20

HZM 29/20 hot-rolled, serrated 

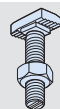
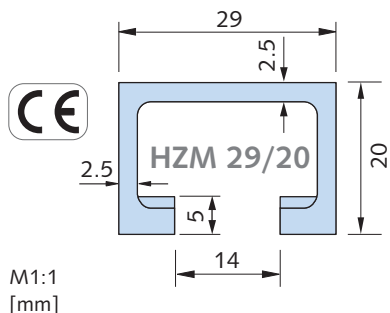

Suitable HALFEN Bolt HZS 29/20 and HS 28/15 → see page 36

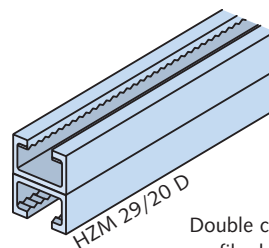
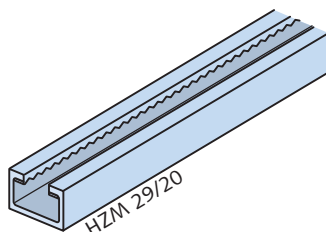

Double channel on request profile data, → see page 62

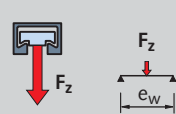
Dimensions and cross section properties									Load capacities				
Material	Order no.	Length [mm]	Weight G [kg/m]	Cross section area A [cm ²]	Moment of inertia		Section modulus		Max. point-load bearing capacity		Bending load capacity at span L		
					I_y [cm ⁴]	I_z [cm ⁴]	W_y [cm ³]	W_z [cm ³]	F_z ① [kN]	$\leq e_w$ [cm]	F [kN]		
HZM 29/20	0284.												
WB	050-00001	6070	1.55	1.98	1.02	2.42	0.91	1.67	$F_{z,Rd}$	15.0	F_{Rd}		
FV	050-00003								11.2		3.3	1.0	0.4
									allow. F_z	allow. F			
									8.0	2.4	0.7	0.3	

① F_z = max. load bearing capacity of the channel lips – see also page 69

Accessories

US DIN 9021
Washer
→ see page 58

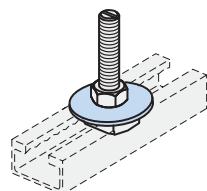

SIC 29/20
Locking washer
→ see page 58

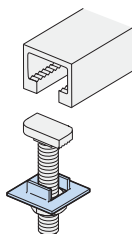

Further design properties

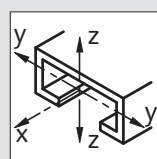

Cross section data
→ page 62

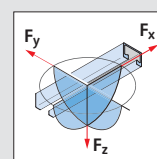

Point-load capacities
→ pages 69

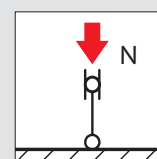

Flexural buckling
→ page 72

HALFEN INDUSTRIAL TECHNOLOGY

Framing Channels – Heavy Duty Framing System

HALFEN Bolts HZS 29/20 and HS 28/15

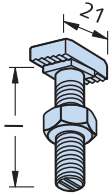

HZS 29/20
HALFEN Bolt
serrated incl. nut

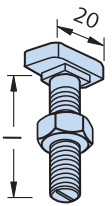

HS 28/15
HALFEN Bolt incl.
nut

i On request
HCR High corrosion resistant
stainless steel HCR for HS 28/15

HZS 29/20 available bolts									
Length l [mm]		M12		Length l [mm]		M12			
30		GVs8.8		125		GVs8.8			
40		GVs8.8		150		GVs8.8			
50		GVs8.8		200		GVs8.8			
60		GVs8.8		250		GVs8.8			
80		GVs8.8		300		GVs8.8			
100		GVs8.8							

HS 28/15 available bolts									
Length l [mm]	M6	M8	M10	M12	Length l [mm]	M6	M8	M10	M12
15	GVs4.6	GVs4.6	GVs4.6	-	50	-	GVs4.6	GVs4.6	GVs4.6
20	GVs4.6	GVs4.6	GVs4.6	-				FV 4.6	GVs4.6
		A2-70	A2-70	-	A4-70	GVs4.6			
25	GVs4.6	GVs4.6	GVs4.6	-	60	-	GVs4.6	GVs4.6	-
		A2-70	A2-70	-				A4-70	GVs8.8
30	GVs4.6	GVs4.6	GVs4.6	GVs4.6	80	-	GVs4.6	GVs4.6	GVs4.6
			FV 4.6	FV 4.6				A4-70	GVs4.6
35	-	-	-	GVs4.6	100	-	GVs4.6	GVs4.6	-
				A4-70				A4-70	A4-50
40	GVs4.6	GVs4.6	GVs4.6	-	125	-	-	GVs4.6	-
			FV8.8	-				A4-50	GVs4.6
40	-	-	A2-70	-	150	-	-	GVs4.6	-
			A4-70	-				A4-50	GVs4.6
40	-	-	A2-70	-	200	-	-	GVs4.6	-
			A4-70	-				A4-50	GVs4.6

Load bearing capacities for HALFEN Bolts ①										
Thread ϕ	Load capacities for HALFEN Bolts				Max. load capacity per bolt in channel longitudinal direction		Recommended torque			
	F [kN] ①				F _x [kN] ①		T _{inst} [Nm]			
29/20	HZS				HZS		HZS			
	8.8				8.8		8.8			
M12	F _{Rd}	27.2			11.2		80			
	allow. F	19.4			8.0					
28/15	HS				HS		HS			
		4.6	8.8	A2/A4-50	A2/A4-70	-	4.6	8.8	A2/A4-50	A2/A4-70
M6	F _{Rd}	2.9	-	-	-	HALFEN Bolts HS are not suitable for longitudinal loads in serrated channels!	3	-	3	-
	allow. F	2.1	-	-	-		8	20	8	15
M8	F _{Rd}	5.3	11.7	-	-		15	40	15	30
	allow. F	3.8	8.3	-	5.5		25	70	25	50
M10	F _{Rd}	8.3	18.6	7.3	15.6					
	allow. F	5.9	13.3	5.2	11.2					
M12	F _{Rd}	12.1	-	-	-					
	allow. F	8.6	-	-	-					

① Note: do not exceed the max. channel load bearing capacity

In case of simultaneous loading in all directions (longitudinal -x, transverse -y, central tension -z) the resultant load must not exceed the load bearing capacity given in the table.

$$\sqrt{F_x^2 + F_y^2 + F_z^2} \leq \text{allow. F}$$

resp.

$$\sqrt{F_{x,Ed}^2 + F_{y,Ed}^2 + F_{z,Ed}^2} \leq F_{Rd}$$

F_x, F_y, F_z = existing loads
 allow. F = allowable load bearing capacity of the bolt
 resp.
 F_{x,Ed}, F_{y,Ed}, F_{z,Ed} = design values of action
 F_{Rd} = design value of resistance

HALFEN INDUSTRIAL TECHNOLOGY

Framing channels – Medium duty system

Framing channels HM 41/41 and HL 41/41

HM 41/41 – HL 41/41 cold-rolled

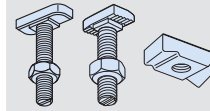

Suitable HALFEN Bolts HS 41/41, HZS 41/41, HZS 41/22 and locking plate → see page 44 – 45

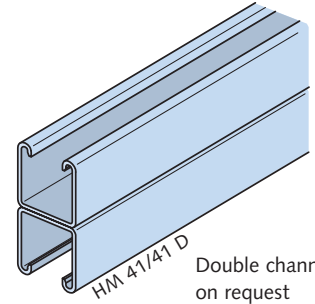
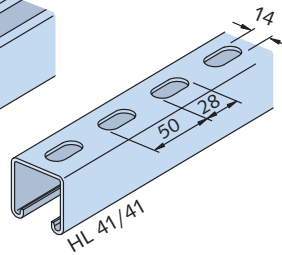
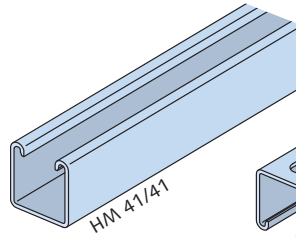

Dimensions and cross section properties									Load capacities				
Material	Order no.	Length	Weight	Cross section area	Moment of inertia		Section modulus		Max. point-load bearing capacity		Bending load capacity at span L		
		[mm]	G [kg/m]	A [cm ²]	I _y [cm ⁴]	I _z [cm ⁴]	W _y [cm ³]	W _z [cm ³]	F _z ① [kN]	≤ e _w [cm]	F [kN]		
											0.5 m	1.0 m	1.5 m
HM 41/41	0280.	6000	2.67	3.4	7.47	9.44	3.24	4.57	F _{z,Rd}	49.0	F _{Rd}		
WB	080-00001								7.8		7.8	3.9	
SV	080-00002								allow. F _z		allow. F		
FV	080-00003								5.6		5.6	2.8	1.9
A4	080-00004												
HL 41/41	0281.	6000	2.46	2.98	6.07	9.16	2.84	4.43	F _{z,Rd}	42.0	0.5 m	1.0 m	1.5 m
WB	010-00001								F _{Rd}				
SV	010-00003								6.6		3.2	2.2	
FV	010-00002								allow. F _z		allow. F		
A4	010-00004								4.7		2.3	1.6	
HM 41/41 D	0280.	6000	5.34	6.81	37.60	18.88	9.10	9.14	F _{z,Rd}	132.0	1.0 m	1.5 m	2.0 m
WB	150-00001								F _{Rd}				
FV	150-00003								10.6		7.1	5.3	
A4	150-00002								allow. F _z		allow. F		
									7.6		5.1	3.8	

① F_z = max. load bearing capacity of the channel lips

Accessories

HPE 41/41 Channel end cap
→ see page 55

PA - 41 Channel cover
→ see page 55

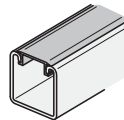
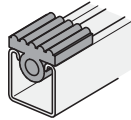
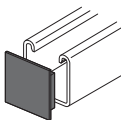

SDM - 41/8 Rubber vibration absorber
→ see MT-FFC catalogue

Further design properties

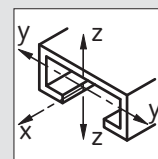

Cross section data
→ pages 64, 66

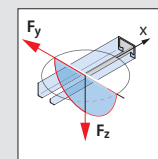

Point-load capacities
→ page 68

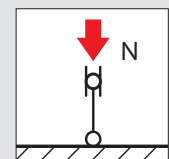

Flexural buckling
→ page 73

HALFEN INDUSTRIAL TECHNOLOGY

Framing channels – Medium duty system

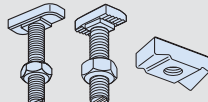

Framing channel HZM 41/41 and HZL 41/41

HZM 41/41 – HZL 41/41 cold-rolled, serrated 

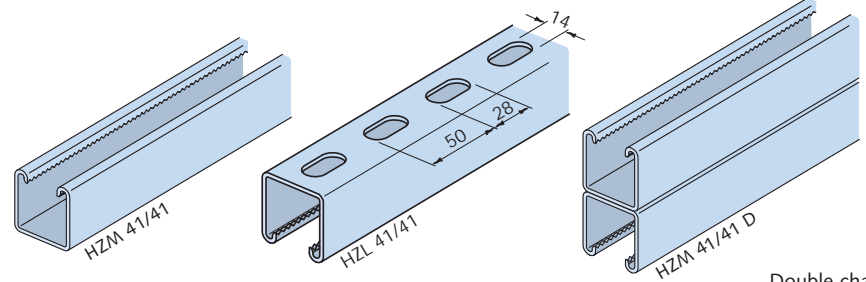
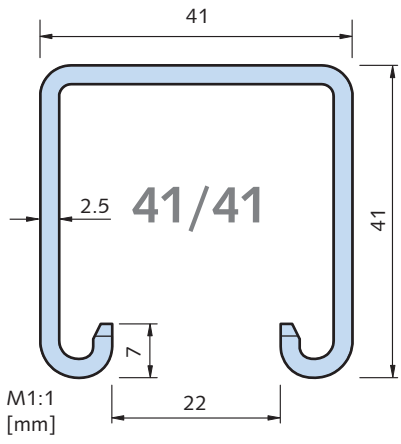
 Suitable HALFEN Bolts HS 41/41, HZS 41/41, HZS 41/22 and locking plates → see pages 44-45

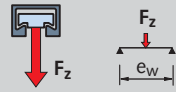

Double channel on request

Dimensions and cross section properties									Load capacities				
Material	Order no.	Length [mm]	Weight G [kg/m]	Cross section area A [cm ²]	Moment of inertia [cm ⁴]		Section modulus [cm ³]		Max. point-load bearing capacity		Bending load capacity at span L		
					I_y	I_z	W_y	W_z	F_z ① [kN]	$\leq e_w$ [cm]	F [kN]		
													
HZM 41/41	0284.	6000	2.63	3.35	7.34	9.37	3.15	4.54	$F_{z,Rd}$	47.0	0.5 m	1.0 m	1.5 m
WB	010-00001								F_{Rd}				
FV	010-00002								7.7		3.8	2.6	
A4	010-00003								allow. F				
											5.5	2.7	1.8
HZL 41/41	0283.	6000	2.46	2.90	5.87	9.04	2.69	4.38	$F_{z,Rd}$	41.0	0.5 m	1.0 m	1.5 m
WB	010-00001								F_{Rd}				
FV	010-00002								6.3		3.2	2.1	
A4	010-00003								allow. F				
											4.5	2.3	1.5
HZM 41/41 D	0284.	6000	5.27	6.7	36.45	18.73	8.83	9.07	$F_{z,Rd}$	126.0	1.0 m	1.5 m	2.0 m
WB	030-00001								F_{Rd}				
FV	030-00002								10.3		6.9	5.2	
A4	030-00003								allow. F				
											7.4	4.9	3.7

① F_z = max. load bearing capacity of the channel lips

Accessories

HPE 41/41 Channel end cap
→ see page 55

PA - 41 Channel cover
→ see page 55

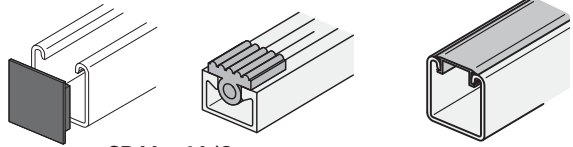

SDM - 41/8
Rubber vibration absorber
→ see catalogue MT-FFC

Further design properties

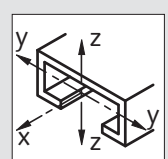

Cross section data
→ pages 64, 66

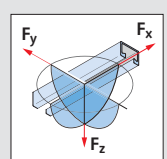

Point-load capacities
→ page 68

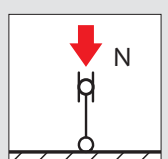

Flexural buckling
→ page 73

HALFEN INDUSTRIAL TECHNOLOGY

Framing channels – Medium duty system

Framing channel HM 41/62 and HL 41/62

HM 41/62 – HL 41/62 cold-rolled

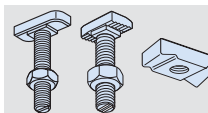
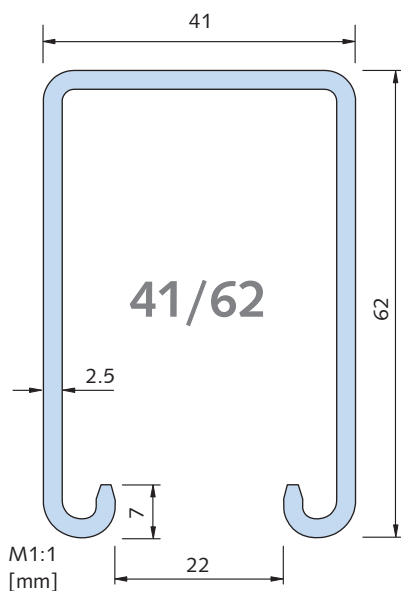

Suitable HALFEN Bolts HS 41/41, HZS 41/41, HZS 41/22 and locking plates → see pages 44–45

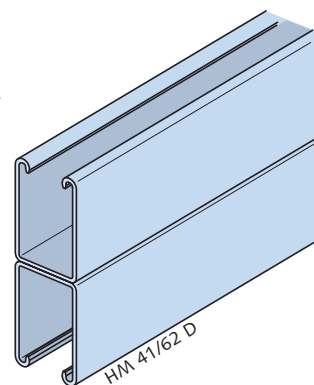
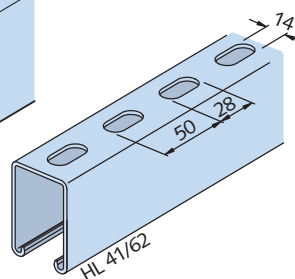
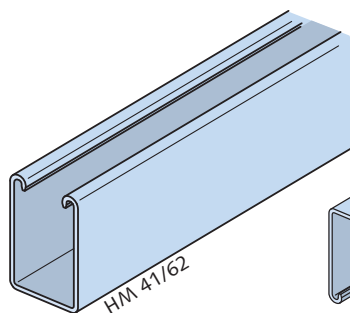

Note, span L: Constructive measures are required to prevent failure caused by bulging, twisting and buckling

Double channel on request

Dimensions and cross section properties								Load capacities						
Material	Order no.	Length [mm]	Weight G [kg/m]	Cross section area A [cm ²]	Moment of inertia		Section modulus		Max. point-load bearing capacity		Bending load capacity at span L			
					I_y [cm ⁴]	I_z [cm ⁴]	W_y [cm ³]	W [cm ³]	F_z ① [kN]	$\leq e_w$ [cm]	F [kN]			
											1.0 m	2.0 m	3.0 m	
HM 41/62	0280.													
WB	140-00002	6000	3.48	4.44	20.96	13.34	6.21	6.46	$F_{z,Rd}$	92.0	F_{Rd}			
									7.8		7.4	3.7	2.2	
FV	140-00003								allow. F_z			allow. F		
									5.6		5.3	2.6	1.6	
HL 41/62	0281.										1.0 m	2.0 m	3.0 m	
WB	040-00001	6000	3.14	3.99	17.27	13.03	5.47	6.31	$F_{z,Rd}$	81.0	F_{Rd}			
SV	040-00003													
FV	040-00002													
											4.5	2.2	1.3	
HM 41/62 D	0280.										1.0 m	1.5 m	2.0 m	
WB	170-00001	6000	6.97	8.88	112.88	26.68	18.21	12.92	$F_{z,Rd}$	269.0	F_{Rd}			
FV	170-00002													
											15.3	10.2	7.7	

① F_z = max. load bearing capacity of the channel lips

Accessories: PA - 41 Channel cover → see page 55

SDM - 41/8 Rubber vibration absorber, see Technical Product Information: "MT-FFC HALFEN Flexible Framing connections".

Further design properties: Cross section data → pages 64, 66

HALFEN INDUSTRIAL TECHNOLOGY

Framing channels – Medium duty system

Framing channel HM 41/83 and HL 41/83

HM 41/83 – HL 41/83 cold-rolled

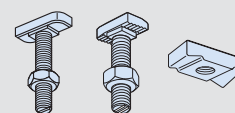
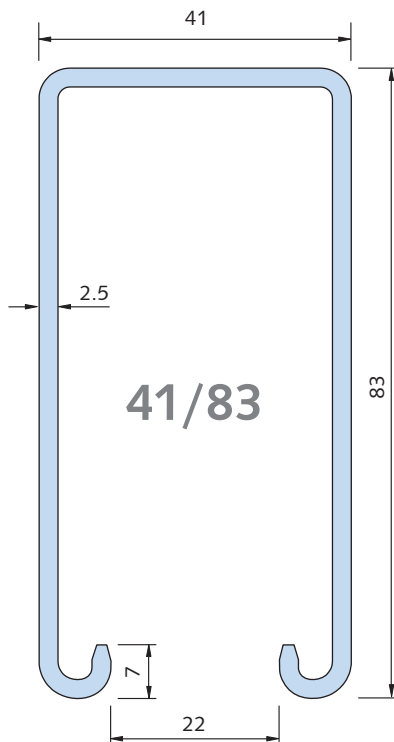
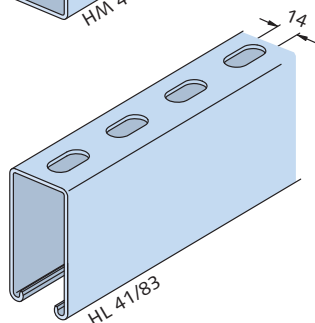
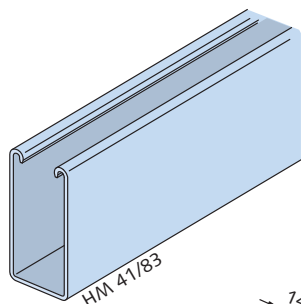

Suitable HALFEN Bolts HS 41/41, HZS 41/41, HZS 41/22 and locking plates → see pages 44–45

Further design properties

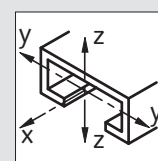

Cross section data
→ pages 64, 66



Note on span L:
Constructive measures are required to prevent failure caused by bulging, twisting and buckling

Dimensions and cross section properties									Load capacities				
Material	Order no.	Length [mm]	Weight G [kg/m]	Cross section area A [cm ²]	Moment of inertia [cm ⁴]		Section modulus [cm ³]		Max. point-load bearing capacity		Bending load capacity at span L		
					I_y	I_z	W_y	W_z	F_z ① [kN]	$\leq e_w$ [cm]	F [kN]		
											1.0 m	2.0 m	3.0 m
HM 41/83	0280.	6000	4.29	5.47	43.82	17.22	9.91	8.34	$F_{z,Rd}$	148.0	F_{Rd}		
WB	130-00002								7.8		11.7	5.9	3.9
SV	130-00001								allow. F_z		allow. F		
FV	130-00003								5.6		8.4	4.2	2.8
HL 41/83	0281.	6000	3.93	5.02	37.07	16.93	8.85	8.20	$F_{z,Rd}$	133.0	1.0 m	2.0 m	3.0 m
WB	030-00004								F_{Rd}				
SV	030-00006								10.2		5.2	3.4	
FV	030-00005								allow. F_z		allow. F		
											7.3	3.7	2.4

① F_z = max. load bearing capacity of the channel lips

Accessories

PA - 41
Channel cover
→ see page 55

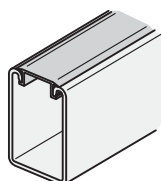

SDM - 41/8
Rubber vibration absorber
→ see MT-FFC catalogue

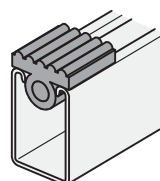

HALFEN INDUSTRIAL TECHNOLOGY

Framing channels – Medium duty system

Framing channel HZL 63/63

HZL 63/63 cold-rolled, serrated 

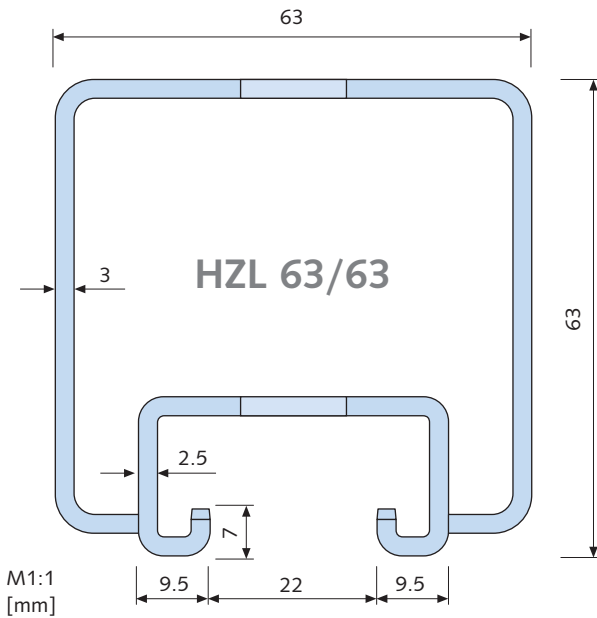

Standard profile for HALFEN Powerclick System 63. More information on the HALFEN Framing System "Powerclick" can be found in Technical Product Information "HALFEN Powerclick PC63".

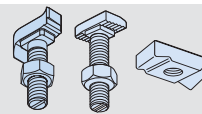

Suitable HALFEN Bolts HS 41/41, HZS 41/41, HZS 41/22 and locking plates → see pages 44–45

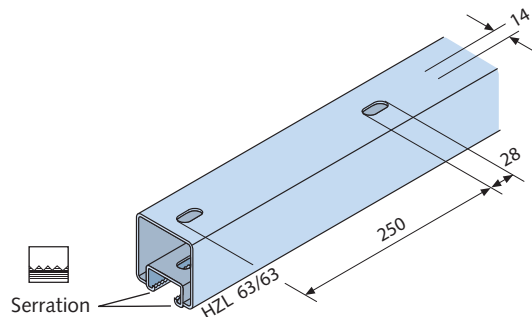

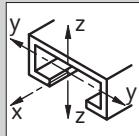
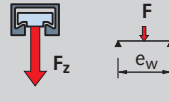
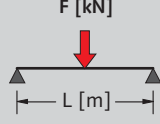
Dimensions and cross section properties								Load capacities					
		Length	Weight	Cross section area	Moment of inertia		Section modulus		Max. point-load bearing capacity		Bending load capacity at span L		
													
Material	Order no.	[mm]	G [kg/m]	A [cm ²]	I _y [cm ⁴]	I _z [cm ⁴]	W _y [cm ³]	W _z [cm ³]	F _z ① [kN]	≤ e _w [cm]	F [kN]		
											0.5 m	1.0 m	1.5 m
HZL 63/63	0283.								F _{z,Rd}	134.0	F _{Rd}		
FV	030-00001	3000	6.35	7.09	33.07	42.95	10.06	13.63	7.8		23.1	11.5	7.7
									allow. F _z			allow. F	
FV	030-00003	6000							5.6		16.5	8.2	5.5

① F_z = max. load bearing capacity of the channel lips

Accessories

HPE 63/63
Channel end cap
→ see page 55

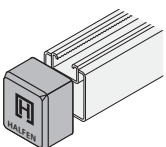

PA - 41
Channel cover
→ see page 55

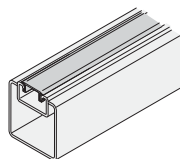

SDM - 41/8
Rubber vibration absorber
→ see catalogue MT-FFC

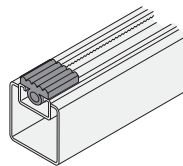

Further design properties

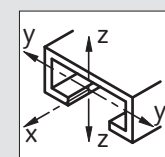

Cross section data
→ page 66

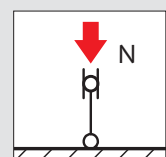

Flexural buckling
→ page 73

HALFEN INDUSTRIAL TECHNOLOGY

Framing channels – Medium duty system

Framing channel HM 41/22 and HL 41/22

HM 41/22 – HL 41/22 cold-rolled

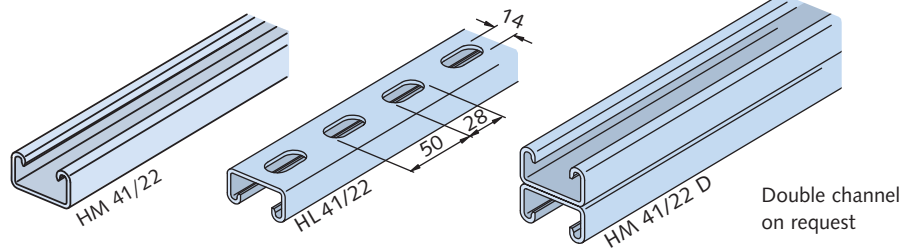
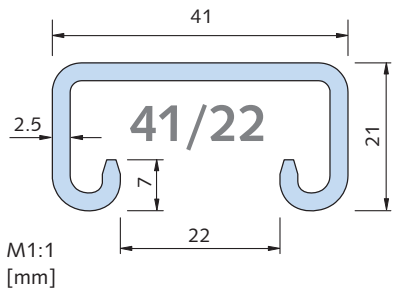
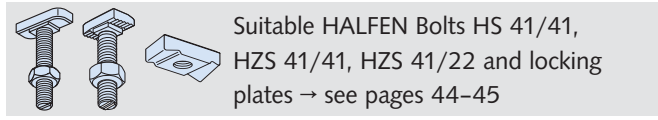

Dimensions and cross section properties									Load capacities						
Material	Order no.	Length	Weight	Cross section area	Moment of inertia		Section modulus		Max. point-load bearing capacity		Bending load capacity at span L				
		[mm]	G [kg/m]	A [cm ²]	I_y [cm ⁴]	I_z [cm ⁴]	W_y [cm ³]	W_z [cm ³]	F_z ① [kN]	e_w [cm]					
HM 41/22	0280.	6000	1.86	2.37	1.28	5.56	1.05	2.69	F_z	15.0	0.5 m	1.0 m	1.5 m		
WB	120-00001								$F_{z,Rd}$					F_{Rd}	
SV	120-00002								7.8						allow. F_z
FV	120-00003								5.6						
A4	120-00004								5.6						
HL 41/22	0281.	6000	1.57	1.95	0.99	5.27	0.89	2.55	F_z	12.0	0.5 m	1.0 m	1.5 m		
WB	020-00001								$F_{z,Rd}$					F_{Rd}	
SV	020-00003								7.8						allow. F_z
FV	020-00002								5.6						
A4	020-00004								5.6						
HM 41/22 D	0280.	6000	3.73	4.75	6.02	11.11	2.91	5.38	F_z	42.0	1.0 m	1.5 m	2.0 m		
WB	160-00001								$F_{z,Rd}$					F_{Rd}	
FV	160-00002								7.8						allow. F_z
A4	160-00003								5.6						
									5.6						

① F_z = max. load bearing capacity of the channel lips

Accessories

HPE 41/22
Channel end cap
→ see page 55

PA - 41
Channel cover
→ see page 55

SDM - 41/8
Rubber vibration absorber
→ see catalogue MT-FFC

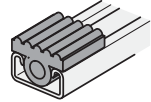
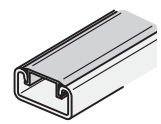
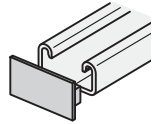

Further design properties

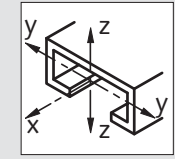

Cross section data
→ page 64, 66

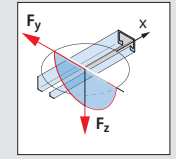

Point-load capacities
→ page 68

HALFEN INDUSTRIAL TECHNOLOGY

Framing channels – Medium duty system

Framing channel HZM 41/22 and HZL 41/22

HZM 41/22 – HZL 41/22 cold-rolled, serrated 

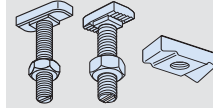

Suitable HALFEN Bolts HS 41/41, HZS 41/41, HZS 41/22 and locking plates → see pages 44–45

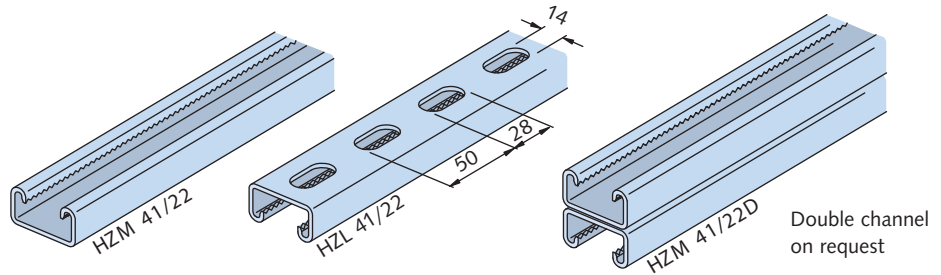
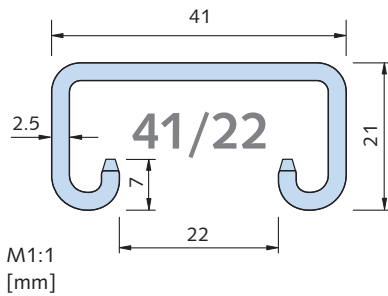

Dimensions and cross section properties									Load capacities				
Material	Order no.	Length [mm]	Weight G [kg/m]	Cross section area A [cm ²]	Moment of inertia		Section modulus		Max. point-load bearing capacity		Bending load capacity at span L		
					I_y [cm ⁴]	I_z [cm ⁴]	W_y [cm ³]	W_z [cm ³]	F_z ① [kN]	$\leq e_w$ [cm]	F [kN]		
HZM 41/22	0284.	6070	1.83	2.33	1.26	5.48	1.03	2.66	$F_{z,Rd}$	14.0	F_{Rd}		
WB	020-00001								7.8		2.7	1.2	0.5
FV	020-00002								allow. F_z		allow. F		
A4	020-00003								5.6		1.9	0.8	0.4
HZL 41/22											0.5 m	1.0 m	1.5 m
WB	020-00001	6000	1.57	1.87	0.97	5.15	0.86	2.49	$F_{z,Rd}$	12.0	F_{Rd}		
FV	020-00002								7.8		2.1	0.8	0.4
A4	020-00003								allow. F_z		allow. F		
									5.6		1.5	0.6	0.3
HZM 41/22 D											1.0 m	1.5 m	2.0 m
WB	040-00001	6070	3.58	4.65	5.83	10.97	2.82	5.31	$F_{z,Rd}$	42.0	F_{Rd}		
FV	040-00002								7.8		3.4	2.2	1.4
A4	040-00003								allow. F_z		allow. F		
									5.6		2.4	1.6	1.0

① F_z = max. load bearing capacity of the channel lips

Accessories

HPE 41/22
Channel end cap
→ see page 55

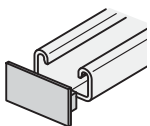

PA - 41
Channel cover
→ see page 55

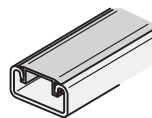

SDM - 41/8
Rubber vibration absorber
→ see catalogue MT-FFC

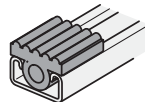

Further design properties

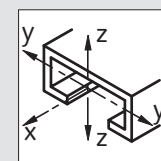

Cross section data
→ pages 64, 66

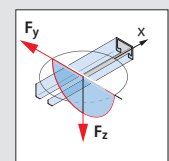

Point-load capacities
→ page 68

HALFEN INDUSTRIAL TECHNOLOGY

Framing channels – Medium duty system

HALFEN Bolts HZS 41/41, HZS 41/22 and HS 41/41

HALFEN Bolts for all 41/... channels:

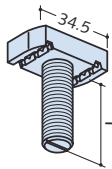

HZS 41/41
HALFEN Bolt
serrated,
order nut separately

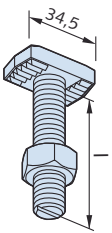

HZS 41/22
HALFEN Bolt serrated,
incl. nut
for serrated channels
41/41, 41/22 and
63/63

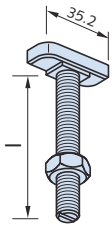

HS 41/41
HALFEN Bolt
incl. nut

HZS 41/41 available bolts					
Length l [mm]	M6	M8	M10	M12	M16 ^{①②}
30	ZL	ZL	ZL	ZL	-
50	-	ZL	ZL	ZL	-
63	-	-	-	-	ZL
75	-	-	ZL	ZL	-
100	-	-	-	ZL	-
				FV4.6	
102	-	-	-	-	ZL ^③

- ① Diameter M16 is not compatible with profile 41/22
 ② Diameter M16 can only be inserted into the slot from the channel end
 ③ On request
 ZL = zinc flake coating

HZS 41/22 available bolts		
Length l [mm]	M12	M16
35	FV8.8	A4-50
	A4-50	-
50	FV8.8	FV8.8
	A4-50	A4-50
80	A4-50	-
100	-	FV8.8

HS 41/41 available bolts		
Length l [mm]	M10	M12
35	FV4.6	FV4.6
	A4-70	A4-70
50	-	FV4.6

Torques for HALFEN Bolts

Thread \varnothing	Recommended torques T_{inst} [Nm]				
	HZS 41/41 Steel	HZS 41/22 8.8	HZS 41/22 A4-50	HS 41/41 4.6	HS 41/41 A4-70
M6	12	-	-	-	-
M8	28	-	-	-	-
M10	55	-	-	15	15
M12	60 ^④	50 ^④	50	25	25
M16	125	80	80	-	-

④ For application with a KUS U-clamp-plate in FV an additional washer EN ISO 7093/DIN 9021 is required.

Load capacities for 41/... HALFEN Bolts

Thread \varnothing	41/...	Load bearing capacities per bolt for centric tension for all 41/.. and 63/.. profiles F_z [kN]					Recommended load capacity per HALFEN Bolt in channel longitudinal direction F_x [kN]				
		HZS 41/41 Steel	HZS 41/22 8.8	HZS 41/22 A4-50	HS 41/41 4.6	HS 41/41 A4-70	HZS 41/41 ^③ Steel	HZS 41/22 8.8	HZS 41/22 A4-50	HZS 41/41 Steel	HZS 41/22 A4-50
M6	F_{Rd}	7.0	-	-	-	-	3.1	-	-	1.4	-
	allow. F	5.0	-	-	-	-	2.2	-	-	1.0	-
M8	F_{Rd}	8.4	-	-	-	-	5.6	-	-	3.4	-
	allow. F	6.0	-	-	-	-	4.0	-	-	2.4	-
M10	F_{Rd}	9.8	-	-	9.0	9.0	7.0	-	-	4.9	-
	allow. F	7.0	-	-	6.4	6.4	5.0	-	-	3.5	-
M12	F_{Rd}	9.8	9.8	9.8	11.2	13.0	7.0	7.0	7.0	5.6	2.4
	allow. F	7.0	7.0	7.0	8.0	9.3	5.0	5.0	5.0	4.0	1.7
M16	F_{Rd}	16.8 ^{①②}	16.8	16.8	-	-	5.6 ^{①②}	7.0	7.0	5.6 ^{①②}	5.6
	allow. F	12.0 ^{①②}	12.0	12.0	-	-	4.0 ^{①②}	5.0	5.0	4.0 ^{①②}	4.0

① Diameter M16 is not compatible with 41/22

② Diameter M16 can only be inserted into the slot from the channel end

③ HZS 41/41 M16 x 102 no serration

HALFEN INDUSTRIAL TECHNOLOGY

Framing channels – Medium duty system

Locking plates GWP 41/41 - SN, - SH, GWP 41/22

GWP 41/41

Locking plate for all 41 channels and 63/63 channels

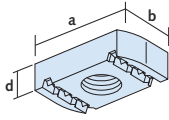

GWP 41/41 SH

Locking plate with long spring for 41/41 channel

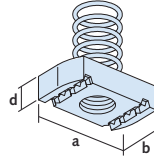

GWP 41/41 SN

Locking plate with short spring for 41/22 and 63/63 channels

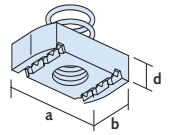

GWP 41/41 available plates

FV	GV	A4	d [mm]	b [mm]	a [mm]
–	M6	M6	6	20	34.5
M8	M8	M8	8/6		
M10	M10	M10	9	20	34.5
FM12	FM12	FM12	9		
M12	M12	–	12	30	34.5
M16	–	M16	12		

F = flat version, fits all 41 and 63 channels

GWP 41/41 SH available plates

GV	d [mm]	b [mm]	a [mm]
M6	6	20	34.5
M8	8		
M10	9	20	34.5
M12	12		

GWP 41/41 SN available plates

GV	d [mm]	b [mm]	a [mm]
M6	6	20	34.5
M8	8		
M10	9	20	34.5
F M12	9		

F = flat version, fits all 41 and 63 channels

GWP 41/22

Locking plate for serrated channels 41/22 and 41/41

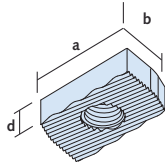

GWP 41/22 available plates

GV	A4	d [mm]	b [mm]	a [mm]
M6	–	7.5	20	34.7
M8	M8			
M10	M10	7.5	20	34.7
M12	M12			
M16	M16	7.5	20	34.7

Torques for 41/... locking plates

Thread Ø	Recommended torques T _{inst} [Nm]			
	GWP 41/41 Steel	GWP 41/41 A4	GWP 41/22 Steel	GWP 41/22 A4
M6	12	6.5	12	6.5
M8	28	16.0	28	16.0
M10	55	31.5	55	31.5
M12	75 ③	–	50 ④	50
FM12	60 ④	55	–	–
M16	125	125	80	80

③ Must not be applied with KUS U-clamp-plate

④ For application with a KUS U-clamp-plate in FV, an additional washer EN ISO 7093/DIN 9021 is required.

Load capacities for 41/... locking plates

Thread Ø	41/...	load bearing capacities for centric tension for all 41 and 63 channels F _z [kN]				Recommended load capacity for locking plates in channel longitudinal direction F _x [kN]				
		GWP41/41 Steel	GWP41/41 A4	GWP41/22 Steel	GWP41/22 A4	GWP41/41 Steel	GWP41/41 A4	GWP41/22 Steel	GWP41/22 A4	GWP 41/41 Steel
M6	F _{Rd}	7.0	7.0	7.0	7.0	3.1	3.1	3.1	–	1.4
	allow. F	5.0	5.0	5.0	5.0	2.2	2.2	2.2	–	1.0
M8	F _{Rd}	8.4	8.4	8.4	8.4	5.6	5.6	5.6	5.6	3.4
	allow. F	6.0	6.0	6.0	6.0	4.0	4.0	4.0	4.0	2.4
M10	F _{Rd}	9.8	9.8	9.8	9.8	7.0	7.0	7.0	7.0	4.9
	allow. F	7.0	7.0	7.0	7.0	5.0	5.0	5.0	5.0	3.5
M12	F _{Rd}	12.6 ①	–	9.8	9.8	7.0 ①	–	7.0	7.0	7.0
	allow. F	9.0 ①	–	7.0	7.0	5.0 ①	–	5.0	5.0	5.0
FM12	F _{Rd}	9.8	9.8	–	–	7.0	7.0	–	–	5.6
	allow. F	7.0	7.0	–	–	5.0	5.0	–	–	4.0
M16 ①②	F _{Rd}	16.8 ①②	9.8 ①②	9.8	9.8	10.5 ①②	7.0 ①②	10.5	7.0	10.5 ①②
	allow. F	12.0 ①②	7.0 ①②	7.0	7.0	7.5 ①②	5.0 ①②	7.5	5.0	7.5 ①②

F = flat version, fits all 41 and 63 channels

① Not compatible with 41/22 and 63/63 channels

② M16 can only be inserted in the slot from the channel end

HALFEN INDUSTRIAL TECHNOLOGY

Framing channels – Light duty system

Framing channel HM 36/36, HL 36/36 and HM 38/17

HM 36/36 – HL 36/36 cold-rolled

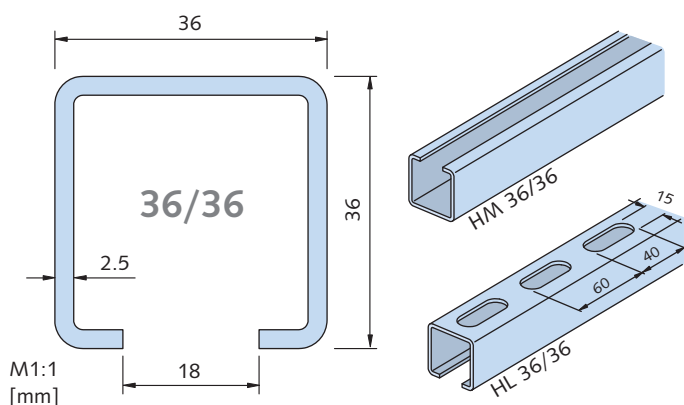

HM 38/17 cold-rolled

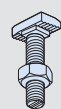
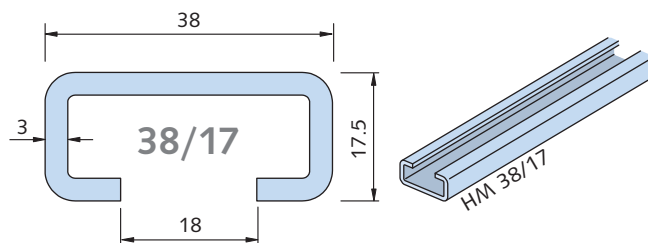

Suitable HALFEN Bolts
HS 38/17 → see page 47

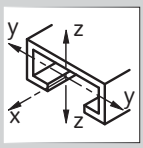
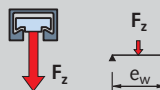
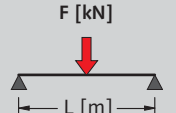
Dimensions and cross section properties									Load capacities				
Material	Order no.	Length [mm]	Weight G [kg/m]	Cross section area A [cm ²]	Moment of inertia 		Section modulus W _y [cm ³] W _z [cm ³]		Max. point-load bearing capacity 		Dending load capacity at span L 		
					I _y [cm ⁴]	I _z [cm ⁴]			F _z ① [kN]	≤ e _w [cm]	0.5 m	1.0 m	1.5 m
HM 36/36	0280.	6000	2.2	2.80	4.54	5.89	2.19	3.27	F _{z,Rd}	44	F _{Rd}		
WB	070-00001								6.2		5.5	2.7	1.8
FV	070-00002								allow. F _z		allow. F		
A4	070-00003								4.4		3.9	1.9	1.3
HL 36/36	0281.	6000	2.0	2.42	3.65	5.78	1.97	3.21	F _{z,Rd}	36	F _{Rd}		
WB	050-00001								6.2		4.5	2.2	1.5
FV	050-00002								allow. F _z		allow. F		
A4	050-00003								4.4		3.2	1.6	1.1
HM 38/17	0290.	6070	1.78	2.27	0.84	4.13	0.80	2.20	F _{z,Rd}	11	F _{Rd}		
WB	020-00001								6.7		2.10	0.84	0.42
FV	020-00002								allow. F _z		allow. F		
A2 ②	020-00003								4.8		1.5	0.6	0.3
A4	020-00004												

① F_z = max. load bearing capacity of the channel lips

② Stainless steel A2 on request; Note: high corrosion resistant stainless steel HCR for HM 38/17 on request

Accessories

PA 18 H Channel cover → see page 55

HPE 36/36 Channel end cap for HM and HL 36/36

→ see page 55

SIC 38/17 Locking washer → see page 58

SDM - 36/6 Rubber vibration absorber → see MT-FFC catalogue

Further design properties

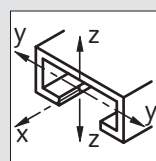

Cross section data
→ pages 64, 66

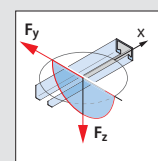

Point-load capacities
→ page 70

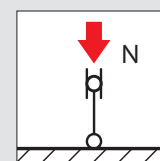

Flexural buckling
→ page 73

HALFEN INDUSTRIAL TECHNOLOGY

Framing channels – Light duty system

HALFEN Bolts HS 38/17

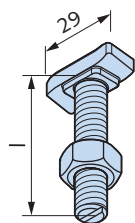

HS 38/17

HALFEN Bolt
incl. nut



On request
HCR High corrosion resistant
stainless steel

HS 38/17 available bolts								
Length l [mm]	M10	M12	M16	Length l [mm]	M10	M12	M16	
20	GVs4.6	GVs4.6	-	60	GVs4.6 A4-70	GVs4.6 GVs8.8 A2-70 A4-70	GVs4.6 FV8.8	
25	-	A4-70	-		70	-	FV8.8	-
30	GVs4.6 FV 4.6 A4-70	GVs4.6 FV4.6 A2-70 A4-70	GVs4.6 FV4.6ⓐ	80		GVs4.6	GVs4.6 A4-70	GVs4.6 FV4.6 A4-50
	40	GVs 4.6 A4-70	GVs4.6 FV4.6 A2-70 A4-70		GVs4.6 FV4.6 A4-50	100	GVs4.6	GVs4.6 A4-50
50		GVs 4.6 FV4.6 A4-70	GVs4.6 FV4.6 A2-70 A4-70	GVs4.6 FV4.6 A4-50 A4-70ⓐ	125		-	GVs4.6
	150	GVs4.6 A4-70	GVs4.6 A2-70 A4-70	GVs4.6 A4-50	150	GVs4.6	GVs4.6	GVs4.6 A4-50
					200	-	GVs4.6	GVs4.6

ⓐ on request

Load bearing capacities for HALFEN Bolts ⓐ

Thread \varnothing	Load capacities for HALFEN Bolts				Recommended load bearing capacities per HALFEN Bolt in channel longitudinal direction			Recommended torques				
	F [kN]	HS				F _x [kN] ⓑ	HS		T _{inst} [Nm]	HS		
		4.6	8.8	A2-50 A4-50	A2-70 A4-70		4.6	8.8		A2-50 A4-50	A2-70 A4-70	
38/17												
M10	F _{Rd}	8.3	18.6	7.3	15.6	0.42	1.54	0.42	15	40	15	30
	allow. F	5.9	13.3	5.2	11.2	0.3	1.1	0.3				
M12	F _{Rd}	12.1	27.0	10.6	22.7	0.7	2.2	0.7	25	70	25	50
	allow. F	8.6	19.3	7.6	16.2	0.5	1.6	0.5				
M16	F _{Rd}	22.6	50.2	19.8	42.2	1.3	4.2	1.26	65	180	60	130
	allow. F	16.1	35.9	14.1	30.2	0.9	3.0	0.9				

ⓐ Note: do not exceed the max. channel load bearing capacity!

ⓑ Load capability through friction

Locking plates

GWP 38/17

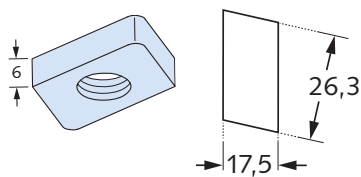

GWP 38/17 available locking plates				
GV	A4	a [mm]	b [mm]	d [mm]
M6	M6	33.5	17.5	6
M8	M8			
M10	M10			
M12	M12			

Load capacities GWP 38/17

Thread	Load capacity [kN]	
	F _{Rd}	allow. F
M6	F _{Rd}	3.1
	allow. F	2.2
M8	F _{Rd}	5.6
	allow. F	4.0
M10	F _{Rd}	8.0
	allow. F	5.7
M12	F _{Rd}	8.0
	allow. F	5.7

HALFEN INDUSTRIAL TECHNOLOGY



Framing channels – Light duty system

Framing channels HM 28/28 and HL 28/28

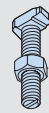
HM 28/28 – HL 28/28 cold-rolled

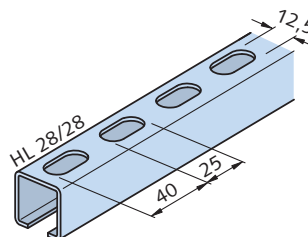
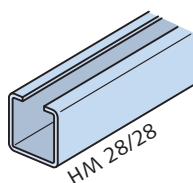
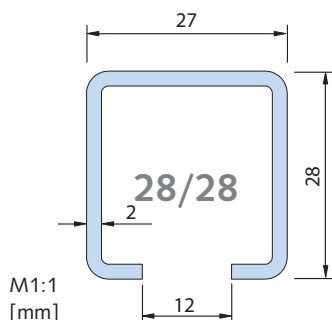
 Suitable HALFEN Bolts
 HS 28/15 → see page 51

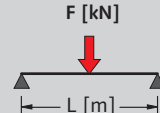

Dimensions and cross section properties								Load capacities					
		Length	Weight	Cross section area	Moment of inertia		Section modulus		Max. point-load bearing capacity		Bending load capacity at span L		
		[mm]	[kg/m]	A [cm ²]	I _y [cm ⁴]	I _z [cm ⁴]	W _y [cm ³]	W _z [cm ³]	 F _z ① [kN]	 ≤ e _w [cm]	 F [kN] over L [m]		
Material	Order no.		G	A	I _y	I _z	W _y	W _z	F _{z,Rd}	31.0	F _{Rd}		
HM 28/28	0280.	6000	1.36	1.73	1.70	2.01	1.08	1.49	4.2			2.7	1.3
WB	050-00001								allow. F _z		allow. F		
SV	050-00003								3.0		1.9	0.9	0.5
FV	050-00002												
A4	050-00004												
HL 28/28	0281.	6000	1.22	1.48	1.33	1.98	0.95	1.47	F _{z,Rd}	25.5	F _{Rd}		
WB	060-00001								4.2			2.10	1.12
SV	060-00003								allow. F _z		allow. F		
FV	060-00002								3.0		1.5	0.8	0.4
A4	060-00004												

① F_z = max. load bearing capacity of the channel lips

Accessories

HPE 28/28 Channel end cap → see page 55

SDM - 28/6 Rubber vibration absorber → see MT-FFC catalogue

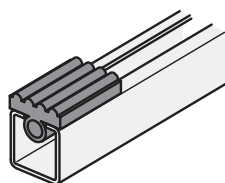
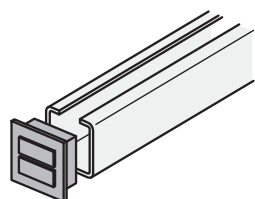

Further design properties

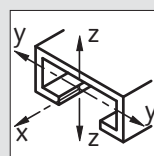

Cross section data → pages 64, 66

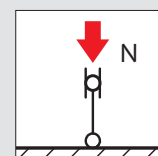

Flexural buckling → page 73

HALFEN INDUSTRIAL TECHNOLOGY

Framing channels – Light duty system

Framing channel HM 28/15 and HL 28/15

HM 28/15 – HL 28/15 cold-rolled

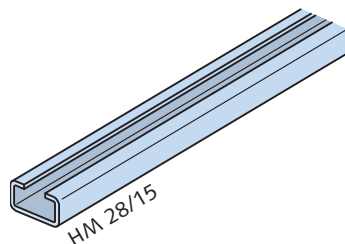
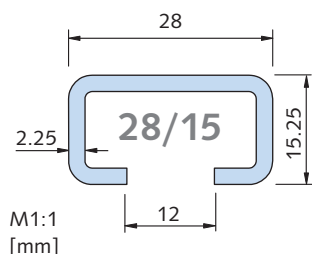

Suitable HALFEN Bolts
HS 28/15 → see page 51

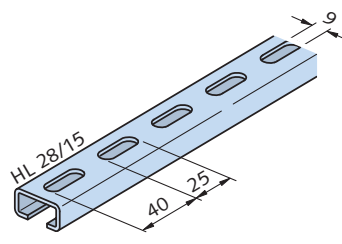

Dimensions and cross section properties									Load capacities							
Material	Order no.	Length [mm]	Weight G [kg/m]	Cross section area A [cm ²]	Moment of inertia		Section modulus		Max. point-load bearing capacity		Bending load capacity at span L					
					I_y [cm ⁴]	I_z [cm ⁴]	W_y [cm ³]	W_z [cm ³]	F_z ① [kN]	$\leq e_w$ [cm]	F [kN]					
											0.5 m	1.0 m	1.5 m			
HM 28/15	0280.	6070	1.09	1.39	0.41	1.45	0.46	1.03		F_z ①	$F_{z,Rd}$	F_{Rd}				
WB	010-00001													1.15	0.38	0.17
FV	010-00002													allow. F		
A2 ②	010-00004													0.82	0.27	0.12
A4 ②	010-00003													allow. F		
HL 28/15	0281.	6070	0.86	1.16	0.32	1.35	0.40	0.98		F_z ①	$F_{z,Rd}$	F_{Rd}				
WB	080-00001													0.98	0.31	0.14
FV	080-00004													allow. F		
A2 ②	080-00002													0.7	0.22	0.10
A4 ②	080-00003													allow. F		

① F_z = max. load bearing capacity of the channel lips

② Stainless steel A2 on request; Note: high corrosion resistant stainless steel HCR for HM 28/15 on request

Accessories

HPE 28/15 Channel end cap
→ see page 55

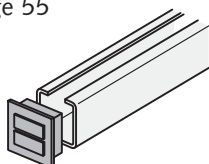

SDM - 28/6 Rubber vibration absorber
→ see MT-FFC catalogue

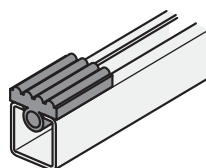

SIC 28/15 Locking washer
→ see page 58

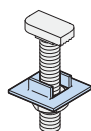

Further design properties

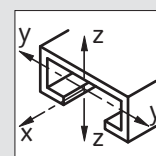

Cross section data
→ pages 64, 66

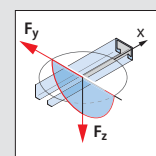

Point-load capacities
→ page 70

HALFEN INDUSTRIAL TECHNOLOGY

Framing channels – Light duty system

Framing channel HM 315 (C30)

HM 315 (C30) cold-rolled

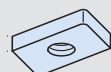

Suitable locking plates
GWP 28/15 → see page 51

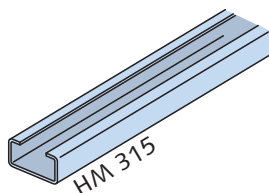
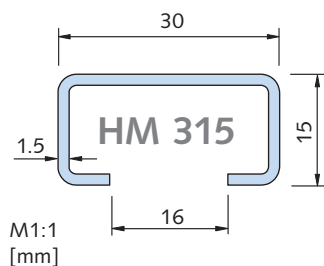

Dimensions and cross section properties

Load capacities

Material	Order no.	Length [mm]	Weight G [kg/m]	Cross section area A [cm ²]	Moment of inertia		Section modulus		Max. point-load bearing capacity		Bending load capacity at span L		
					I_y [cm ⁴]	I_z [cm ⁴]	W_y [cm ³]	W_z [cm ³]	F_z ① [kN]	$\leq e_w$ [cm]	F [kN]		
HM 315	0280.										0.5 m	1.0 m	1.5 m
WB	060-00001	6000	0.77	0.97	0.30	1.26	0.32	0.84	$F_{z,Rd}$	17.7	F_{Rd}		
	2.32								0.81		0.28	0.13	
FV	060-00002								allow. F_z		allow. F		
									1.66		0.58	0.20	0.09

① F_z = max. load bearing capacity of the channel lips

Accessories

SIC 28/15 Locking plate
→ see page 58

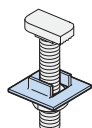

Further design properties

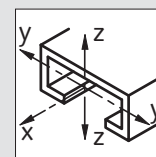

Cross section data
→ page 64

HALFEN INDUSTRIAL TECHNOLOGY

Framing channels – Light duty system

HALFEN Bolts HS 28/15

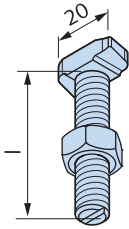

HS 28/15
HALFEN Bolts
incl. nut

Not for HM 315



On request
HCR High corrosion resistant
stainless steel

HS 28/15 available bolts

Length l [mm]	M6	M8	M10	M12	Length l [mm]	M6	M8	M10	M12
15	GVs4.6	GVs4.6	GVs4.6	-	50	-	GVs4.6	GVs4.6	GVs4.6
20	GVs4.6	GVs4.6 GVs8.8 A2-70 A4-70	GVs4.6 FV4.6 A2-70 A4-70	-		GVs4.6	GVs4.6 GVs8.8 A4-70	GVs4.6	-
	25	GVs4.6	GVs4.6 A2-70	GVs4.6 A2-70 A4-70	-	80	-	GVs4.6	GVs4.6
30		GVs4.6	GVs4.6 A2-70 A4-70	GVs4.6 FV4.6 A2-70 A4-70	GVs4.6	100	-	GVs4.6	GVs4.6
	35	-	-	-	GVs4.6	125	-	-	GVs4.6
40		GVs4.6	GVs4.6	GVs4.6 FV8.8 A2-70 A4-70	-	150	-	-	GVs4.6
					200	-	-	GVs4.6	
								A4-50	

① on request

Load bearing capacities for HALFEN Bolts ①

Thread \varnothing	Load capacities for HALFEN Bolts				Recommended load bearing capacity per HALFEN Bolt in channel longitudinal direction		Recommended torque				
	F_y	F_z	F [kN]		F_x [kN] ②		T_{inst} [Nm]				
28/15	HS										
	4.6	8.8	A2-50 A4-50	A2-70 A4-70	4.6; 8.8	A2-50; A4-50; A2-70; A4-70	4.6	8.8	A2-50 A4-50	A2-70 A4-70	
M6	F_{Rd}	2.9	6.4	2.5	5.4	0.14	0.14	3	-	3	-
	allow. F	2.1	4.6	1.8	3.8	0.1	0.1				
M8	F_{Rd}	5.3	11.7	4.6	9.9	0.28	0.28	8	20	8	15
	allow. F	3.8	8.3	3.3	7.1	0.2	0.2				
M10	F_{Rd}	8.3	18.6	7.3	15.6	0.42	0.42	15	40	15	30
	allow. F	5.9	13.3	5.2	11.2	0.3	0.3				
M12	F_{Rd}	12.1	27.0	10.6	22.7	0.7	0.7	25	70	25	50
	allow. F	8.6	19.3	7.6	16.2	0.5	0.5				

① Note: do not exceed the max. channel load bearing capacity

② Load capability through friction

Locking plates

GWP 28/15

for profiles 28/15 and HM 315 (C30)

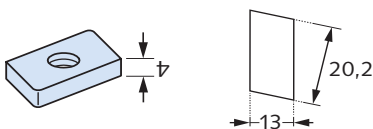

Assembly notes:

M6 and M8: insert the locking plate at an angle through the channel slot!

M10: insert the locking plate first, then screw in the bolt!

GWP 28/15 available locking plates

GV	A4	a [mm]	b [mm]	d [mm]
M5	-	20.2	13.0	4
M6	M6			
M8	M8			
M10	M10	18.6	17.0	5

GWP 28/15 Load capacities

Thread	F_z [kN]	
	F_{Rd}	allow. F
M5	F_{Rd}	2.1
	allow. F	1.5
M6	F_{Rd}	2.7
	allow. F	1.9
M8	F_{Rd}	3.9
	allow. F	2.8
M10	F_{Rd}	4.2
	allow. F	3.0

HALFEN INDUSTRIAL TECHNOLOGY

Framing channels – Light duty system

Framing channel HM 20/12 and HL 20/12

HM 20/12 – HL 20/12 cold-rolled

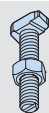

Suitable HALFEN Bolt
HS 20/12 → see page 53

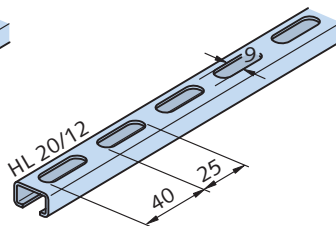
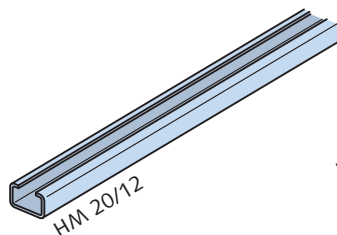
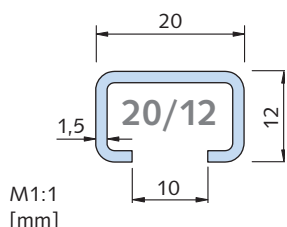

Dimensions and cross section properties									Load capacities				
Material	Order no.	Length [mm]	Weight G [kg/m]	Cross section area A [cm ²]	Moment of inertia		Section modulus		Max. point-load bearing capacity		Bending load capacity at span L		
					I_y [cm ⁴]	I_z [cm ⁴]	W_y [cm ³]	W_z [cm ³]	F_z ① [kN]	$\leq e_w$ [cm]	F [kN]		
HM 20/12	0280.	6000	0.52	0.66	0.12	0.36	0.16	0.36	$F_{z,Rd}$	5.8	F_{Rd}		
WB	030-00001								3.14		0.42	0.11	0.06
FV	030-00003								allow. F_z		allow. F		
A2	030-00002								2.24		0.30	0.08	0.04
HL 20/12	0281.	6000	0.45	0.53	0.09	0.35	0.14	0.36	$F_{z,Rd}$	4.6	F_{Rd}		
WB	090-00001								3.14		0.32	0.08	0.04
FV	090-00002								allow. F_z		allow. F		
A2	090-00003								2.24		0.23	0.06	0.03

① F_z = max. load bearing capacity of the channel lips

Accessories

SIC 20/12 Locking washer
→ see page 58

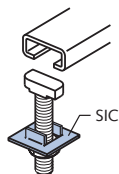

Further design properties

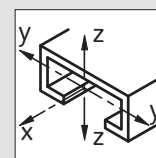

Cross section data
→ pages 64, 66

HALFEN INDUSTRIAL TECHNOLOGY

Framing channels – Light duty system

HALFEN Bolts HS 20/12

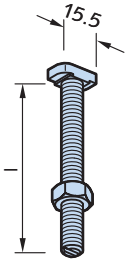

HS 20/12
HALFEN Bolts
incl. nut

HS 20/12 available bolts

Length l [mm]	HS 20/12 available bolts		Length l [mm]	HS 20/12 available bolts	
	M6	M8		M6	M8
15	-	GVs4.6	40	GVs4.6	GVs4.6
20	GVs4.6	GVs4.6 A2-70	50	-	GVs4.6 A2-70 ①
25	-	GVs4.6	60	-	GVs4.6
30	GVs4.6	GVs4.6 A2-70	80	-	GVs4.6

① on request

Load bearing capacities for HALFEN Bolts ①

Thread \varnothing	Load capacities for HALFEN Bolts		Recommended load capacity per HALFEN Bolt in channel longitudinal direction		Recommended torque		
	F_y F_z	F [kN]	F_x	F_z	T_{inst} [Nm]		
20/12	HS		HS		HS		
		4.6	A2-70	4.6	A2-70	4.6	A2-70
M6	F_{Rd}	2.9	5.4	0.14	0.14	3	-
	allow. F	2.1	3.8	0.1	0.1		
M8	F_{Rd}	5.3	9.9	0.28	0.28	8	8
	allow. F	3.8	7.1	0.2	0.2		

① Note: do not exceed the max. channel load bearing capacity

② Load capability through friction

Locking plates

Locking plate GWP 20/12

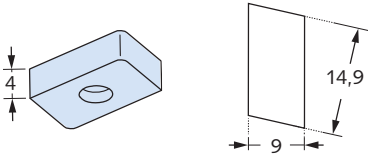

GWP 20/12 available locking plates

GV Thread	A4 Thread	a [mm]	b [mm]	d [mm]
M5	M5	14.5	9	4
M6	M6			

Load capacities for GWP 20/12

Thread	F_z [kN]	
	F_{Rd}	allow. F
M5	F_{Rd}	2.1
	allow. F	1.5
M6	F_{Rd}	2.7
	allow. F	1.9

ACCESSORIES / FRAMING CHANNELS

The benefits at a glance

We provide a wide selection of accessories to complement the HALFEN range of framing channels. We can provide everything you need for your project; all from a single source.



Fast and economical

- Complete freedom in positioning and dimensioning the bolt connections
- Fast installation and adjustment of all components and connected equipment
- Dirt-free and low-noise on-site modifications or upgrades
- Clever modular system, numerous accessory components available
- No more welding in hazardous environments
- Corrosion protection of system components isn't damaged by bolting

HALFEN Framing channels used with the appropriate accessories – i.e. HALFEN Bolts, locking plates – provide all the advantages for adaptable bolt connections and framing systems.

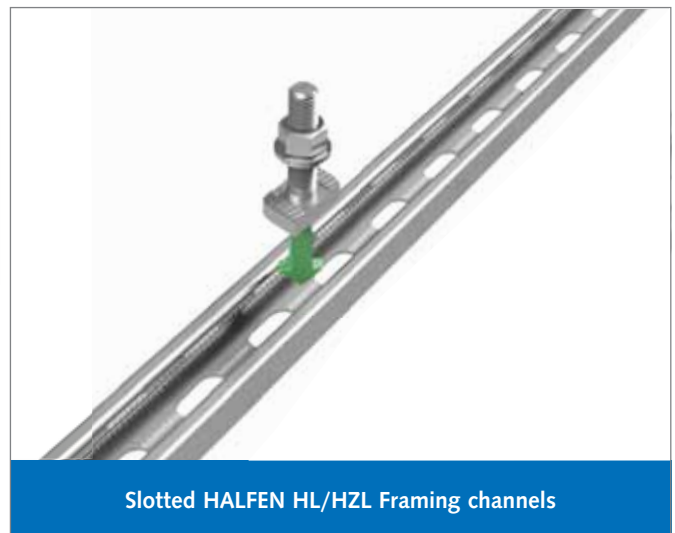

Our wide range of accessories for HALFEN Framing channels include bolts and matching nuts in various sizes and finishes.

A wide range of accessories is also available for our slotted framing channels. → See pages 55, 58, 59.



Channel end caps

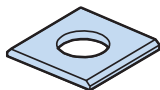

Washers

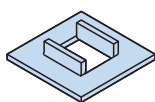

Locking washers



Nuts

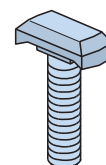

T-bolts



Ring nuts

HALFEN INDUSTRIAL TECHNOLOGY

HPE Channel end caps

HPE Channel end caps (plastic)



Type **HPE 63/63**
Colour: blue

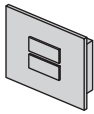

Type **HPE**
Colour: black

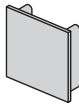

Type **HPE 41/41**
Type **HPE 41/22**
Colour: black

Product range		
Description	Order no. 0318.000-	Suitable for channel
HPE 63/63	00010	63/63
HPE 52/34	00001	52/34
HPE 50/40	00002	50/40
HPE 41/41	00003	41/41
HPE 41/22	00004	41/22
HPE 36/36	00005	36/36
HPE 28/28	00006	28/28
HPE 28/15	00011	28/15

Assembly diagram:

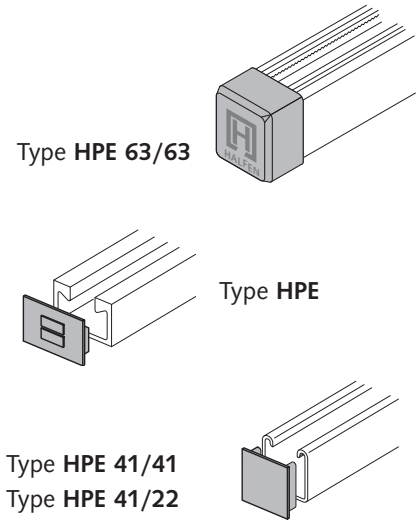

PA Channel cover

The PA Channel cover is used to protect the channel slot against dirt etc.

Type overview

Type	PA 41	PA 22	PA 18 H
	Suitable for profiles: 50/40, 50/30, 486, all 41/... Profiles	Suitable for profile 52/34	Suitable for profiles 36/36, 38/17
Quality: hard PVC (KS)	 white	 medium grey	 medium grey
Quality: steel sendzimir zinc plated (SV)	 white		

Assembly diagram:

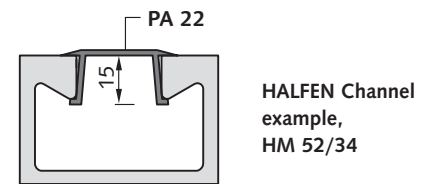

Order numbers

Type	Length [mm]	Order no. 0321.000-
PA - 41 - KS	- 3000	00002
PA - 41 - SV	- 3000	00001
PA - 22 - KS	- 3000	00003
PA - 18H - KS	- 3000	00004

HALFEN INDUSTRIAL TECHNOLOGY

Available products – Overview of HALFEN Bolts

For channel	HM 72/48				HM/HL 55/42, 52/34, 50/30, 49/30, 50/40, 50/40, 486				HM 52/34 HM 50/30		HM 40/22, HM 40/25, HM 422			HM 40/22	HM 36/36, HL 36/36, HM 38/17			
	HS 72/48				HSR 72/48	HS 50/30 ① ②				HSR 50/30		HS 40/22 ②			HSR 40/22	HS 38/17 ①		
Ø																		
l	M20	M24	M27	M30	M20	M10	M12	M16	M20	M16	M20	M10	M12	M16	M16	M10	M12	M16
[mm]																		
15																		
20																		
25																		
30																		
35																		
40																		
45																		
50																		
55																		
60																		
63																		
65																		
70																		
75																		
80																		
100																		
100 T																		
125																		
150																		
175																		
200																		
250																		
300																		

T = with partial thread; ZL = zinc flake coated

① High corrosion resistant stainless steel HALFEN Bolts, HCR on request

HALFEN INDUSTRIAL TECHNOLOGY

Nuts and washers

1 FRAMING CHANNELS
2 HEAVY DUTY SYSTEM
3 MEDIUM DUTY SYSTEM
4 LIGHT DUTY SYSTEM
5 ACCESSORIES
6 STATICS
7 MECHANICAL ENGINEERING

MU
Hexagonal nuts
EN ISO 4032/
DIN 934

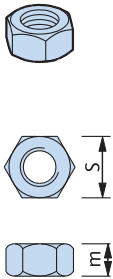

GV galvanized FK 8 thread	A4 stainless steel Bolt	S/m DIN [mm]	S/m ISO [mm]
M6	M6	10/5	10/5.2
M8	M8	13/6.5	13/6.8
M10	M10	17/8	16/ 8.4
M12	M12	19/10	18/10.8
M16	M16	24/13	24/14.8
M20	M20	30/16	30/18
M24	-	36/19	36/21.5
FV hot-dip galvanized thread	A2 stainless steel Bolt	S/m DIN [mm]	S/m ISO [mm]
M6	-	10/5	10/5.2
M8	M8	13/6.5	13/6.8
M10	M10	17/8	16/8.4
M12	M12	19/10	18/10.8
M16	M16	24/13	24/14.8

VUS
Square washers

FV Hot-dip galvanized Bolt size	A4 Stainless steel Bolt size	a × b × d [mm]
M10	M10	40 × 40 × 5
M12	M12	40 × 40 × 5
M16	M16	40 × 40 × 5

VUS 40/25
for profile
40/25;
HZA
41/22

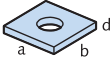

VUS 49/30
for profile
54/33,
49/30

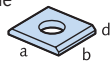

VUS 52/34
for profile
52/34,
50/30

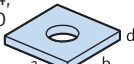

VUS 72/49
for profile
72/48,
72/49

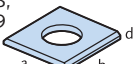

VUS 41/41
for all
41/..
profiles

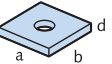

M10	M10	37 × 37 × 5
M12	M12	37 × 37 × 5
M16	M16	37 × 37 × 5
M20	M20	37 × 37 × 5

M16	M16	50 × 50 × 6
M20	M20	50 × 50 × 6

M20	M20	54 × 54 × 6
M24	M24	54 × 54 × 6
M27	M27	54 × 54 × 6
M30	M30	54 × 54 × 6

M6	M6	40 × 40 × 6
M10	M10	40 × 40 × 6
M12	M12	40 × 40 × 6

Ordering example: **VUS 52/34 - FV - M20**

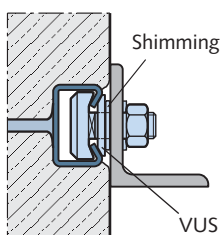

Application VUS:
for shimming non-flush
installation of HALFEN
Anchor channels or for
stand-off installations
→ see page 69.

US
Washers
DIN EN
ISO 7093/
DIN 9021;
DIN EN ISO
7094

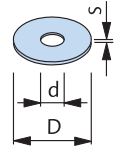

DIN/ ISO	GV galvanized, bolt	A4 stainless steel bolt	D [mm]	d [mm]	s [mm]
7094	M6	-	22	6.6	2
9021	M8	M8	24	8.4	2
9021	M10	M10	30	10.5	2.5
7094	M12	-	45	13.5	4
9021	M12	M12	37	13	3
9021	M16	M16	50	17	3
7094	M20	-	72	22	6
	FV hot-dip galv. bolt		D [mm]	d [mm]	s [mm]
9021	M10	-	30	10.5	2.5
9021	M12	-	37	13	3
9021	M16	-	50	17	3

Ordering example: **US - M12 - GV - DIN 9021**

US
Washers
DIN EN
ISO 7089/
DIN 125

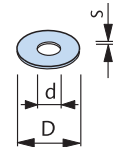

GV galvanized bolt	A4 Stainless steel bolt	D [mm]	d [mm]	s [mm]
M6	M6	12	6.4	1.6
M8	M8	16	8.4	1.6
M10	M10	21	10.5	2
M12	M12	24	13	2.5
M16	M16	30	17	3
M20	M20	37	21	3
M24	-	44	25	4
FV Hot-dip galvanized	A2 Stainless steel bolt	D [mm]	d [mm]	s [mm]
-	M8	17	8.4	1.6
M10	M10	21	10.5	2
M12	M12	24	13	2.5
M16	M16	30	17	3
M20	-	37	21	3
M27	-	50	28	4

Ordering example: **US - M12 - GV - DIN 125**

SIC
Locking
washer

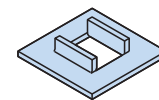

GV galvanized	A4 Stainless steel A4	Suitable for HALFEN bolts Type	Dimensions
SIC - 50/30 - GV	SIC - 50/30 - A4	50/30	M16, M20
SIC - 40/22 - GV	SIC - 40/22 - A4	38/17 40/22	M16
SIC - 38/23 - GV	-	38/23	M16
SIC - 29/20 - GV	-	29/20	M12
SIC - 38/17 - GV	SIC - 38/17 - A4	38/17 40/22	M12, M10
SIC - 28/15 - GV	SIC - 28/15 - A4	28/15	M8, M10
SIC - 20/12 - GV	SIC - 20/12 - A4	20/12	M8

Ordering example: **SIC - 38/17 - GV**

Assembly:

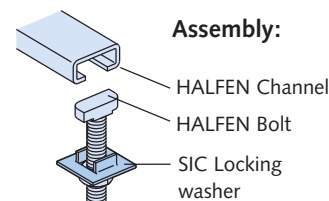

Application SIC:

to secure and prevent
HALFEN Bolts
back-turning
during assembly.

HALFEN INDUSTRIAL TECHNOLOGY

Threaded rods, Hexagonal head bolts, Coupler sleeves, Ring nuts

GWS

Threaded rods
DIN 976-1

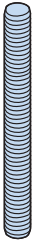

GV	A4	Length	F _{Rd}	allow. F
Galvanized F.k. 4.6 Thread	Stainless steel A4 Thread	[mm]	① [kN]	[kN]
M6	M6	1000	3.1	2.2
M8	M8	1000	5.6	4.0
M10	M10	1000	9.0	6.4
M12	M12	1000	13.0	9.3
M16	M16	1000	24.2	17.3
M20	M20	1000	37.8	27.0
M24	-	1000	54.3	38.8

Ordering example: **GWS - M12 × 1000 - GV**

VBM

Coupler sleeves,
round

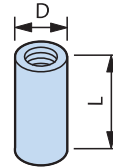

GV	A4	D	L	F _{Rd}	allow. F
Galvanized Thread	Stainless steel Thread	[mm]	[mm]	① [kN]	[kN]
M6	M6	10/10	15	3.1	2.2
M8	M8	12/14	20	5.6	4.0
M10	M10	13/16	25	9.0	6.4
M12	M12	16/20	30	13.0	9.3
M16	M16	21/25	40	24.2	17.3
M20	M20	26/32	50	37.8	27.0

Ordering example: **VBM - A4 - M16**

HSK

Hexagonal head
bolts
EN ISO 4017/
DIN 933
(without nut)

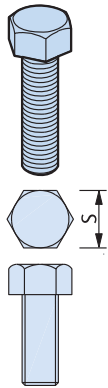

Hex bolts are used
in combination with
HALFEN Locking
plates

GV 8.8	A4	S	S
Galvanized FK 8.8 Dimensions	Stainless steel Dimensions	DIN [mm]	EN ISO [mm]
M 6 × 12	-	10	10
M 6 × 25	-	13	13
M 8 × 25	M 8 × 25	13	13
M 8 × 40	-	17	16
M 10 × 20	-	17	16
M 10 × 30	M 10 × 30	17	16
M 10 × 45	M 10 × 45	17	16
M 10 × 60	-	19	18
M 10 × 70	-	19	18
M 12 × 22	-	19	18
M 12 × 25	M 12 × 25	19	18
M 12 × 30	M 12 × 30	19	18
M 12 × 40	M 12 × 40	19	18
M 12 × 50	-	24	24
M 12 × 60	M 12 × 60	24	24
M 12 × 80	M 12 × 80	24	24
M 12 × 90	-	24	24
M 16 × 40	M 16 × 40	24	24
M 16 × 60	M 16 × 60	24	24
M 16 × 90	M 16 × 90	24	24

SKM

Hexagonal coup-
ler sleeves with
view holes

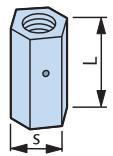

FV	A4	S	L	F _{Rd}	allow. F
Hot-dip galvanized Thread	Stainless steel Thread	[mm]	[mm]	① [kN]	[kN]
M10	M10	13	40	9.0	6.4
M12	M12	17	40	13.0	9.3
M16	M16	22	50	24.2	17.3

Ordering example: **SKM - FV - M12**

SPH

Turnbuckles
with right-
and left-hand
thread

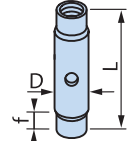

f = min. screw
depth
M12 ≅ 10mm
M16 ≅ 13 mm

A4	A4	D	D
Stainless steel Thread M12 × Length L [mm]	Stainless steel Thread M16 × Length L [mm]	For M12 [mm]	For M16 [mm]
M 12 × 60	M 16 × 60	16	22
M 12 × 75	M 16 × 75	16	22
M 12 × 95	M 16 × 95	16	22
M 12 × 115	M 16 × 115	16	22
M 12 × 135	M 16 × 135	16	22
allow. F = 5 kN F _{Rd} = 7 kN	allow. F = 10 kN F _{Rd} = 14 kN		

Ordering example: **SPH - A4 - M12 x 75**

HJV

Adjustment
coupler

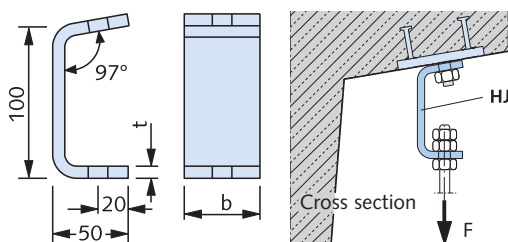
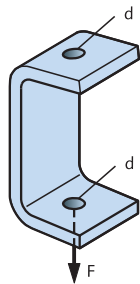

FV	A4	t	b	d	max. F _{Ed}	allow. F
Hot-dip galvanized Type	Stainless steel Type	[mm]	[mm]	[mm]	② [kN]	[kN]
1	1	6	40	13	2.1	1.5
2	2	8	50	17	4.6	3.3
3	3	10	50	17	7.0	5

RM

Ring nut
DIN 582
from 2010-09



GV	d	F _{Rd}	allow. F
C 15E, galvanized Thread	[mm]	① [kN]	[kN]
M8	20	2.0	1.4
M10	25	3.2	2.3
M12	30	4.8	3.4
M16	35	9.8	7.0
M20	40	16.8	12.0

Ordering example: **RM - GV - M12**

- ① Recommended design value of the load capacity with a centric tensile stress
- ② Recommended design value of the load

HALFEN ADJUSTABLE CANTILEVER

The advantages at a glance

A revolution in tunnel pipe supports, the HALFEN Adjustable cantilever combines the established high load bearing of the medium duty system with much faster installation. It is specifically designed for tunnels or other projects with curved or inclined surfaces, and, being fully adjustable, it is not necessary to know the exact cantilever angle during planning.



No custom cantilever brackets required, no angles to measure

- › simplified design
- › easy planning
- › lower risk of planning errors
- › quick delivery; in-stock item, therefore no lead time as for custom production

One product for all positions dramatically reduces complexity

- › suitable for pipe clamps, shoes and cable trays
- › can be used for laid or suspended pipes
- › compensates for on-site tolerances. Remains fully adjustable

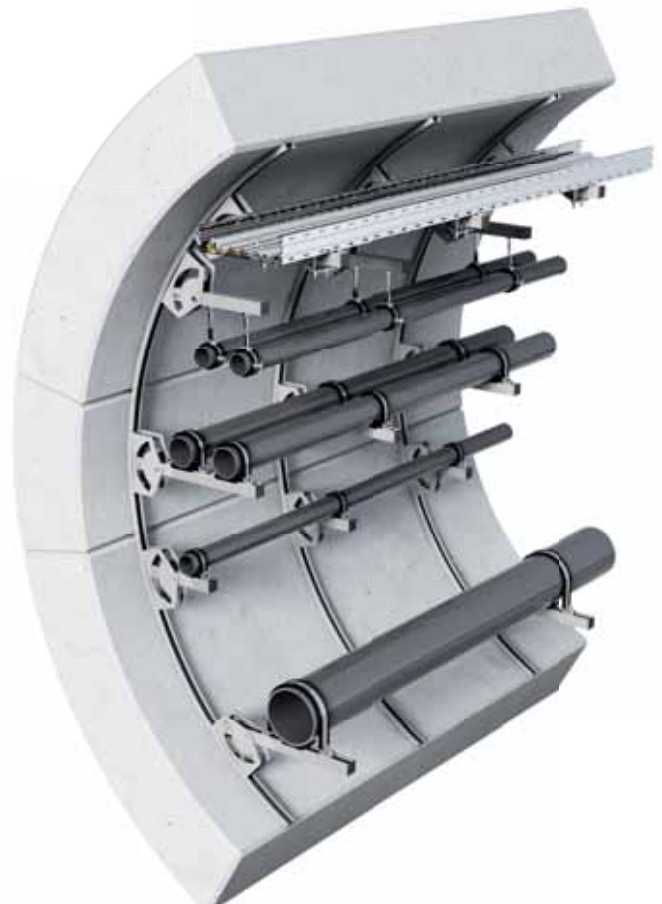

Further information on HALFEN Cantilevers is available at www.halfen.com
Also see our Flexible Framing Connections catalogue:
"HALFEN MT-FFC Flexible Framing Connections" Technical Product Information.



HALFEN INDUSTRIAL TECHNOLOGY

Cantilever brackets

Cantilevers KON

Flexible comprehensive support system
 For low load or for very high load requirements: you are guaranteed to find the most cost-efficient solution for all requirements in our range of products. The versatile bolt connections allow components to be assembled, disassembled, re-positioned or adjusted quickly and easily.

Short assembly times
 The adaptability of HALFEN Cantilevers and bolts make them ideal when the sizes and positions of bolts cannot be defined during the planning stage of a project. Using our range of products avoids costly and complex adjusting, drilling or thread cutting in corrosion protected components.



Pipe supports with cantilevers brackets in a sewage treatment plant

Cantilever 52:

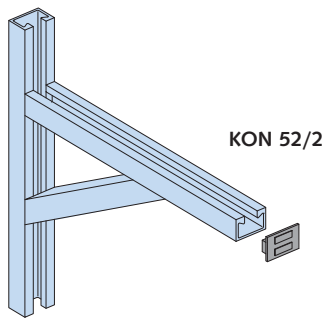

Cantilever 41:

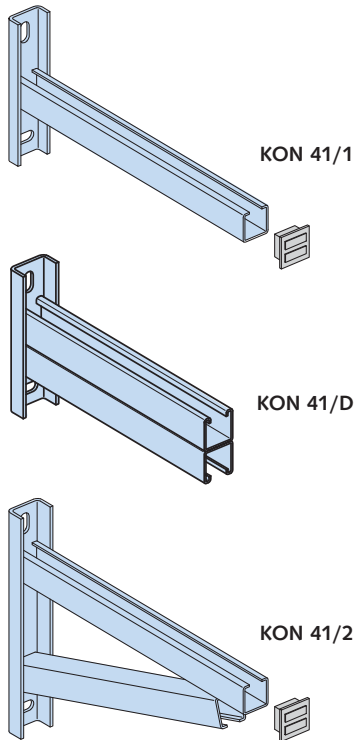

Cantilever 36/28:

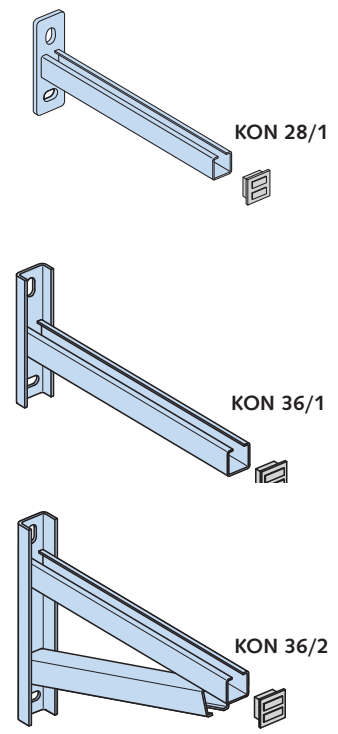

Note: Depending on the number of required brackets, custom cantilevers are available for all types

1	FRAMING CHANNELS
2	HEAVY DUTY SYSTEM
3	MEDIUM DUTY SYSTEM
4	LIGHT DUTY SYSTEM
5	ACCESSORIES
6	STATICS
7	MECHANICAL ENGINEERING

HALFEN INDUSTRIAL TECHNOLOGY

HALFEN Framing channels, Hot-rolled, Non-slotted – Channel specifications overview

Material: steel, type WB, FV E= 210.000 N/mm²

Bending load capacity at span L (single span element) ②

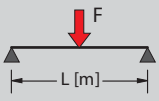
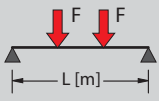
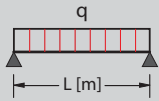
F [kN]		F [kN]		q [kN/m]	
allow. F _z	F _{Rd}	allow. F _z	F _{Rd}	allow. F _z	F _{Rd}
0.50 m		1.00 m		1.50 m	
22.3	31.2	11.2	15.6	7.4	10.4
16.8	23.5	8.4	11.7	5.6	7.8
8.8	12.3	4.4	6.1	2.8	3.9
5.4	7.5	2.7	3.7	1.6	2.2
2.6	3.7	1.3	1.9	0.6	0.8
0.50 m		1.00 m		1.50 m	
16.7	23.4	8.4	11.7	5.6	7.8
12.6	17.6	6.3	8.8	3.3	4.6
6.6	9.2	3.3	4.6	1.6	2.3
4.0	5.6	2.0	2.8	0.9	1.3
2.0	2.8	0.8	1.1	0.3	0.5
0.50 m		1.00 m		1.50 m	
89.3	125.0	22.3	31.2	9.9	13.9
67.0	93.8	16.8	23.5	6.0	8.4
35.1	49.1	8.8	12.3	3.0	4.2
21.4	30.0	5.4	7.5	1.7	2.3
10.6	14.8	2.1	3.0	0.6	0.9
1.00 m		2.00 m		3.00 m	
33.7	47.2	16.8	23.6	11.2	15.7
24.5	34.3	12.2	17.1	7.9	11.0
12.5	17.4	6.2	8.7	3.8	5.4
7.0	9.8	3.5	4.9	2.0	2.8
3.5	4.9	1.7	2.4	0.8	1.1
1.00 m		2.00 m		3.00 m	
25.3	35.4	12.6	17.7	8.4	11.8
18.4	25.7	9.2	12.8	4.6	6.5
9.3	13.1	4.7	6.5	2.3	3.2
5.3	7.4	2.6	3.7	1.2	1.6
2.6	3.7	1.0	1.4	0.4	0.6
0.50 m		1.00 m		1.50 m	
24.8	34.8	12.4	17.4	7.1	10.0
12.4	17.3	6.2	8.6	2.7	3.8
6.8	9.5	2.6	3.7	1.2	1.6
4.2	5.9	1.4	2.0	0.6	0.9
2.4	3.3	0.7	1.0	0.3	0.4
0.50 m		1.00 m		1.50 m	
99.4	139.1	24.8	34.8	7.6	10.6
49.4	69.2	9.9	13.8	2.9	4.1
27.2	38.1	4.2	5.9	1.2	1.7
16.8	23.5	2.3	3.2	0.7	0.9
8.8	12.3	1.1	1.5	0.3	0.5
1.00 m		2.00 m		3.00 m	
34.8	48.7	17.4	24.3	9.6	13.4
16.5	23.1	7.8	10.9	3.5	4.8
9.3	13.0	3.3	4.7	1.5	2.1
5.5	7.6	1.7	2.4	0.7	1.0
3.2	4.4	0.9	1.2	0.4	0.5
1.00 m		2.00 m		3.00 m	
69.5	97.3	17.2	24.1	5.1	7.1
33.0	46.2	6.2	8.7	1.8	2.6
18.6	26.0	2.7	3.7	0.8	1.1
10.8	15.1	1.3	1.9	0.4	0.6
5.5	7.7	0.7	1.0	0.2	0.3

All load capacities are calculated using the elastic-plastic method acc. to EN 1993-1, partial safety factor $\gamma_F = 1.4$; deflection $\leq l / 150$.
 Determination of the allowable value
allow. F_z = F_{Rd} / 1.4

Note: For stainless steel framing channels the bending deflection value must be verified separately using the valid (elasticity) E-modulus.

HALFEN INDUSTRIAL TECHNOLOGY

HALFEN Framing Channels, Cold-Rolled, Non-Slotted – Channel specifications overview

Material: steel, type WB, FV, SV E= 210.000 N/mm²

Bending load capacity at span L (single span element) ②

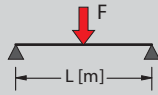

F [kN]

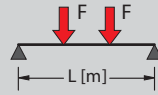

F [kN]

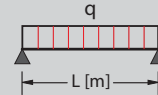

q [kN/m]

allow. F _z	F _{Rd}	allow. F _z	F _{Rd}	allow. F _z	F _{Rd}	allow. F _z	F _{Rd}	allow. F _z	F _{Rd}	allow. F _z	F _{Rd}	allow. F _z	F _{Rd}	allow. q _z	q _{Rd}	allow. q _z	q _{Rd}	allow. q _z	q _{Rd}
0.50 m		1.00 m		1.50 m		0.50 m		1.00 m		1.50 m		0.50 m		1.00 m		1.50 m			
4.3	6.1	2.2	3.0	1.2	1.7	3.3	4.6	1.6	2.3	0.7	1.0	17.4	24.3	4.3	6.1	1.3	1.9		
2.6	3.6	1.3	1.8	0.6	0.9	1.9	2.7	0.8	1.1	0.4	0.5	10.3	14.5	2.2	3.1	0.7	0.9		
6.8	9.5	3.4	4.7	2.3	3.2	5.1	7.1	2.5	3.5	1.5	2.1	27.0	37.8	6.8	9.5	2.8	3.9		
3.3	4.6	1.7	2.3	0.9	1.2	2.5	3.5	1.2	1.6	0.5	0.7	13.2	18.5	3.2	4.5	0.9	1.3		
1.8	2.5	0.9	1.2	0.4	0.5	1.3	1.9	0.5	0.7	0.2	0.3	7.1	10.0	1.4	1.9	0.4	0.6		

allow. F _z	F _{Rd}	allow. F _z	F _{Rd}	allow. F _z	F _{Rd}	allow. F _z	F _{Rd}	allow. F _z	F _{Rd}	allow. F _z	F _{Rd}	allow. F _z	F _{Rd}	allow. q _z	q _{Rd}	allow. q _z	q _{Rd}	allow. q _z	q _{Rd}
0.50 m		1.00 m		1.50 m		0.50 m		1.00 m		1.50 m		0.50 m		1.00 m		1.50 m			
5.6	7.8	2.8	3.9	1.9	2.6	4.2	5.9	2.1	2.9	1.3	1.8	22.3	31.2	5.6	7.8	2.4	3.3		
5.5	7.7	2.7	3.8	1.8	2.6	4.1	5.7	2.1	2.9	1.3	1.8	21.9	30.6	5.5	7.7	2.3	3.3		
1.9	2.7	0.9	1.2	0.4	0.5	1.5	2.0	0.5	0.7	0.2	0.3	7.8	10.9	1.4	1.9	0.4	0.6		
1.9	2.7	0.8	1.2	0.4	0.5	1.4	2.0	0.5	0.7	0.2	0.3	7.6	10.6	1.4	1.9	0.4	0.6		

allow. F _z	F _{Rd}	allow. F _z	F _{Rd}	allow. F _z	F _{Rd}	allow. F _z	F _{Rd}	allow. F _z	F _{Rd}	allow. F _z	F _{Rd}	allow. F _z	F _{Rd}	allow. q _z	q _{Rd}	allow. q _z	q _{Rd}	allow. q _z	q _{Rd}
1.00 m		2.00 m		3.00 m		1.00 m		2.00 m		3.00 m		1.00 m		2.00 m		3.00 m			
8.4	11.7	4.2	5.9	2.8	3.9	6.3	8.8	3.1	4.4	1.9	2.7	16.8	23.5	4.2	5.9	1.7	2.4		
5.3	7.4	2.6	3.7	1.6	2.2	3.9	5.5	2.0	2.8	0.9	1.3	10.5	14.7	2.6	3.7	0.8	1.2		

allow. F _z	F _{Rd}	allow. F _z	F _{Rd}	allow. F _z	F _{Rd}	allow. F _z	F _{Rd}	allow. F _z	F _{Rd}	allow. F _z	F _{Rd}	allow. F _z	F _{Rd}	allow. q _z	q _{Rd}	allow. q _z	q _{Rd}	allow. q _z	q _{Rd}
1.00 m		1.50 m		2.00 m		1.00 m		1.50 m		2.00 m		1.00 m		1.50 m		2.00 m			
7.6	10.6	5.1	7.1	3.8	5.3	5.7	8.0	3.8	5.3	2.8	4.0	15.2	21.2	6.7	9.4	3.8	5.3		
7.4	10.3	4.9	6.9	3.7	5.2	5.5	7.7	3.7	5.2	2.8	3.9	14.8	20.7	6.6	9.2	3.7	5.2		
2.5	3.5	1.7	2.3	1.0	1.4	1.9	2.6	1.1	1.5	0.6	0.8	5.0	6.9	1.9	2.7	0.8	1.1		
2.4	3.4	1.6	2.2	1.0	1.4	1.8	2.5	1.0	1.4	0.6	0.8	4.8	6.7	1.9	2.6	0.8	1.1		
15.3	21.4	10.2	14.3	7.7	10.7	11.5	16.1	7.7	10.7	5.7	8.0	30.6	42.9	13.6	19.1	7.7	10.7		

allow. F _z	F _{Rd}	allow. F _z	F _{Rd}	allow. F _z	F _{Rd}	allow. F _z	F _{Rd}	allow. F _z	F _{Rd}	allow. F _z	F _{Rd}	allow. F _z	F _{Rd}	allow. q _z	q _{Rd}	allow. q _z	q _{Rd}	allow. q _z	q _{Rd}
0.50 m		1.00 m		1.50 m		0.50 m		1.00 m		1.50 m		0.50 m		1.00 m		1.50 m			
3.9	5.5	1.9	2.7	1.3	1.8	2.9	4.1	1.5	2.0	0.8	1.1	15.6	21.8	3.9	5.5	1.4	2.0		
1.5	2.1	0.6	0.8	0.3	0.4	1.1	1.6	0.3	0.5	0.15	0.2	5.9	8.3	0.9	1.3	0.3	0.4		
0.6	0.8	0.2	0.3	0.1	0.1	0.4	0.6	0.12	0.16	0.05	0.07	2.3	3.2	0.3	0.4	0.1	0.1		
1.9	2.6	0.9	1.3	0.5	0.7	1.4	2.0	0.7	0.9	0.3	0.4	7.5	10.5	1.8	2.6	0.5	0.8		
0.8	1.2	0.3	0.4	0.12	0.17	0.6	0.9	0.16	0.2	0.07	0.1	3.3	4.6	0.4	0.6	0.13	0.2		
0.3	0.42	0.08	0.11	0.03	0.05	0.18	0.26	0.05	0.06	0.02	0.03	1.0	1.40	0.12	0.17	0.04	0.05		

All load capacities were calculated using the elastic-plastic method acc. to EN 1993-1, partial safety factor $\gamma_F = 1.4$; deflection $\leq l / 150$.

Determination of the allowable value
 $\text{allow. } F_z = F_{Rd} / 1.4$

Note: For stainless steel framing channels the bending deflection value must be verified separately using the valid (elasticity) E-modulus.

Material: Steel, type WB, FV, SV E= 210.000 N/mm²

Bending load capacity at span L (single span element) ②

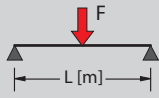

F [kN]

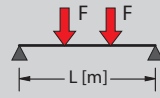

F [kN]

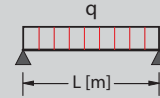

q [kN/m]

allow. F _z	F _{Rd}	allow. F _z	F _{Rd}	allow. F _z	F _{Rd}	allow. F _z	F _{Rd}	allow. F _z	F _{Rd}	allow. F _z	F _{Rd}	allow. q _z	q _{Rd}	allow. q _z	q _{Rd}	allow. q _z	q _{Rd}
0.50 m		1.00 m		1.50 m		0.50 m		1.00 m		1.50 m		0.50 m		1.00 m		1.50 m	
5.7	7.98	2.9	4.06	1.9	2.66	4.3	6.02	2.1	2.94	1.3	1.82	22.9	32.06	5.7	7.98	2.3	3.22

allow. F _z	F _{Rd}	allow. F _z	F _{Rd}	allow. F _z	F _{Rd}	allow. F _z	F _{Rd}	allow. F _z	F _{Rd}	allow. F _z	F _{Rd}	allow. q _z	q _{Rd}	allow. q _z	q _{Rd}	allow. q _z	q _{Rd}
0.50 m		1.00 m		1.50 m		0.50 m		1.00 m		1.50 m		0.50 m		1.00 m		1.50 m	
16.5	23.1	8.2	11.5	5.5	7.7	12.4	17.4	6.2	8.7	4.1	5.7	66	92.4	16.5	23.1	7.3	10.2
4.7	6.6	2.3	3.2	1.6	2.2	3.5	4.9	1.7	2.4	1.1	1.5	18.7	26.2	4.7	6.6	1.9	2.7
1.6	2.2	0.7	1.0	0.3	0.4	1.2	1.7	0.4	0.6	0.17	0.2	6.2	8.7	1.1	1.5	0.3	0.4
4.5	6.3	2.3	3.2	1.5	2.1	3.4	4.8	1.7	2.4	1	1.4	18.1	25.3	4.5	6.3	1.9	2.7
1.5	2.1	0.6	0.8	0.3	0.4	1.1	1.5	0.4	0.6	0.16	0.2	6	8.4	1	1.4	0.3	0.4

allow. F _z	F _{Rd}	allow. F _z	F _{Rd}	allow. F _z	F _{Rd}	allow. F _z	F _{Rd}	allow. F _z	F _{Rd}	allow. F _z	F _{Rd}	allow. q _z	q _{Rd}	allow. q _z	q _{Rd}	allow. q _z	q _{Rd}
1.00 m		2.00 m		3.00 m		1.00 m		2.00 m		3.00 m		1.00 m		2.00 m		3.00 m	
7.3	10.2	3.7	5.2	2.4	3.4	5.5	7.7	2.8	3.9	1.6	2.2	14.7	20.6	3.7	5.2	1.5	2.1
4.5	6.3	2.2	3.1	1.3	1.8	3.4	4.8	1.7	2.4	0.8	1.1	9	12.6	2.2	3.1	0.7	1.0

allow. F _z	F _{Rd}	allow. F _z	F _{Rd}	allow. F _z	F _{Rd}	allow. F _z	F _{Rd}	allow. F _z	F _{Rd}	allow. F _z	F _{Rd}	allow. q _z	q _{Rd}	allow. q _z	q _{Rd}	allow. q _z	q _{Rd}
0.50 m		1.00 m		1.50 m		0.50 m		1.00 m		1.50 m		0.50 m		1.00 m		1.50 m	
3.20	4.48	1.60	2.24	1.10	1.54	2.40	3.36	1.20	1.68	0.60	0.84	12.90	18.06	3.20	4.48	1.20	1.68
1.50	2.10	0.80	1.12	0.40	0.56	1.10	1.54	0.50	0.70	0.23	0.32	6.10	8.54	1.40	1.96	0.40	0.56
0.70	0.98	0.22	0.31	0.10	0.14	0.50	0.70	0.13	0.18	0.06	0.08	2.70	3.78	0.30	0.42	0.10	0.14
0.23	0.32	0.06	0.08	0.03	0.04	0.14	0.20	0.04	0.06	0.02	0.03	0.80	1.12	0.10	0.14	0.03	0.04

- ① Minimum distance a_e between the channel end and the load point (HALFEN Bolt, locking plate) a_e ≥ 40 mm, The load point must not be located past the outer fixing positions.
- ② Do not exceed the bolt load capacity or the max. channel load bearing capacity.
- ③ For maximum point-load capacity:
F_z = max, load bearing capacity of the channel lips.
- ④ Take constructive measures to prevent failure caused by bulging, tilting and buckling.
- ⑤ On request.

All load capacities were calculated using the elastic-plastic method acc. to EN 1993-1, partial safety factor γ_F = 1.4; deflection ≤ l / 150. Determination of the allowable value
allow. F_z = F_{Rd} / 1.4.

Note: For stainless steel framing channels the bending deflection value must be verified separately using the valid (elasticity) E-modulus.

HALFEN INDUSTRIAL TECHNOLOGY

Load Bearing Capacities for Welded or Bolted HALFEN Framing Channels

Hot-rolled HM Framing channels welded or bolted to structural elements

NEW!

Loads acc. to
ETA-19/0438

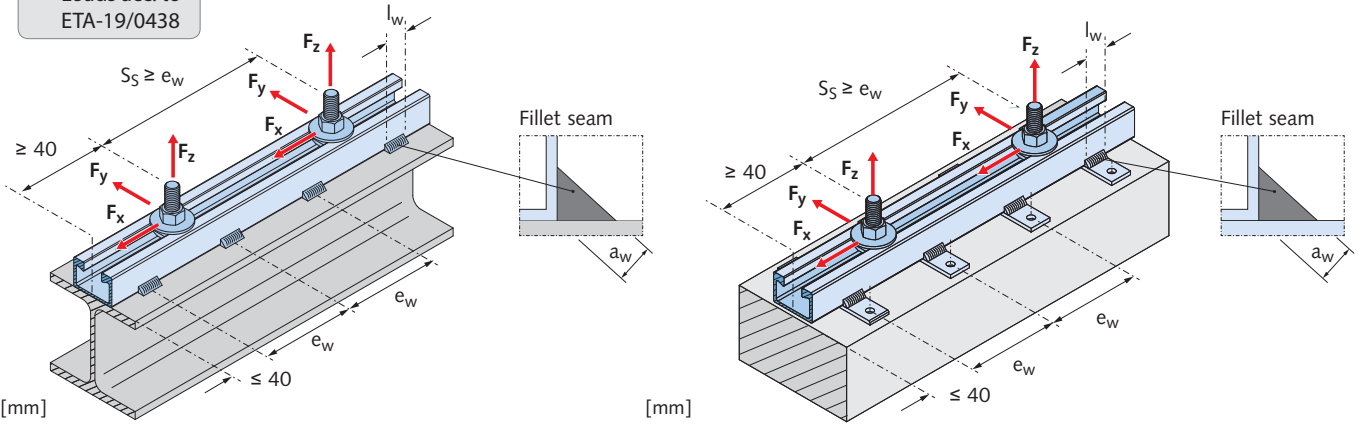

Load bearing capacities for hot-rolled HM Framing channels, no serration

Hot rolled channels	Weld seams			Point-load bearing capacity ① ③				HALFEN Bolts
	a _w [mm]	l _w [mm]	e _w [mm]	allowable loads F ₂ [kN]		Design resistance values F _{Rd} ① [kN]		spacings
				allow. F _z	allow. F _y	F _{z,Rd}	F _{y,Rd}	S _s
HM 72/48	5	50	300	47.6	19.8	66.7	27.8	S _s ≥ e _w
HM 55/42	4	30	250	39.7	17.9	55.6	25.0	
HM 52/34	4	30	200	27.0	15.1	37.8	21.1	
HM 50/30	4	30	200	15.1	10.7	21.1	15.0	
HM 40/22	3	30	150	10.3	5.6	14.4	7.8	

③ Observe the bolt load capacities

① In cases of simultaneous loading in all directions the following criterion must be met:



$$\left(\frac{F_z}{\text{allow. } F_z}\right)^2 + \left(\frac{F_y}{\text{allow. } F_y}\right)^2 \leq 1$$

resp.

$$\left(\frac{F_{z,Ed}}{F_{z,Rd}}\right)^2 + \left(\frac{F_{y,Ed}}{F_{y,Rd}}\right)^2 \leq 1$$

F_y, F_z = existing load;
F = allowable point-load capacity

resp.

F_{y,Ed}, F_{z,Ed} = Design values of action
F_{y,Rd}, F_{z,Rd} = Design values of resistance
(Design load capacities)

① The bearing capacities are for loads acting on the front edge of the channel. For off-set transverse load (e.g. stand-off installations) the bending moment of the bolt must be considered and superimposed with the tensile load, see page 71.

HALFEN INDUSTRIAL TECHNOLOGY

Load Bearing Capacities for Welded or Bolted HALFEN Framing Channels

Framing channels welded or bolted to structural elements

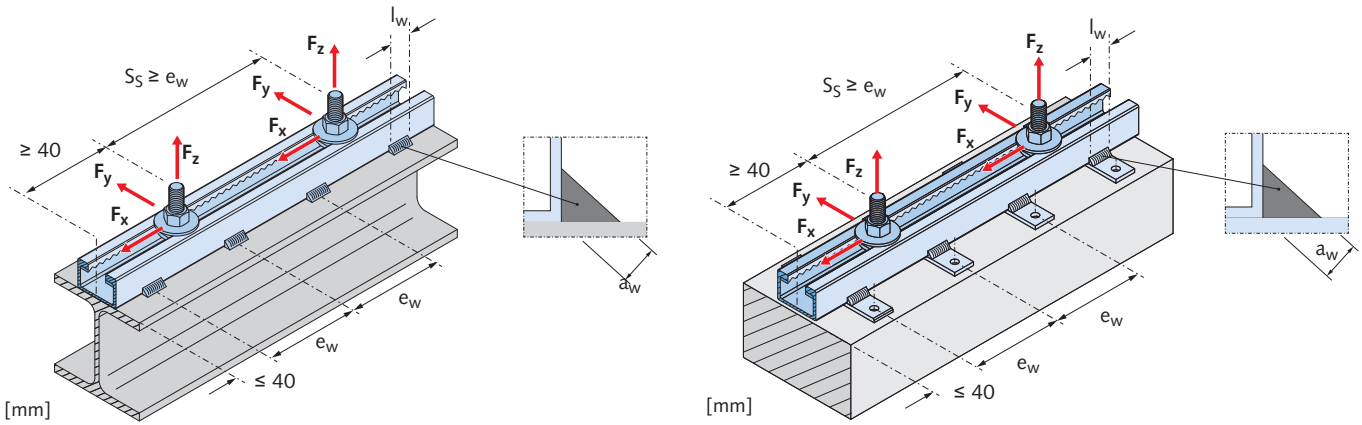

Load bearing capacities for hot-rolled serrated HZM Channels

Hot-rolled channels	Weld seams			Point-load bearing capacity ①						HALFEN Bolts	
	a_w [mm]	l_w [mm]	e_w [mm]	allowable loads $F_{\text{②}}$ [kN]			Design resistance values F_{Rd} ① [kN]			size	spacings
				allow. F_z	allow. F_y	allow. F_x	$F_{z,\text{Rd}}$	$F_{y,\text{Rd}}$	$F_{x,\text{Rd}}$	\varnothing [mm]	S_s
HZM 64/44	5	40	250	38.1	12.5	27.0	53.3	17.4	37.8	M24	$S_s \geq e_w$
HZM 53/34	4	30	200	30.9	9.3	22.0/19.0③	43.3	13.1	30.8/26.6③	M20	
HZM 41/27	4	30	200	17.8	4.4	12.0	25.0	6.2	16.8	M16	
HZM 38/23	4	30	200	12.8	4.2	12.0	18.0	5.9	16.8	M16	
HZM 29/20	3	30	150	8.0	1.5	8.0	11.2	2.0	11.2	M12	

③ For stainless steel

① In cases of simultaneous loading in all directions the following criterion must be met:



$$\frac{F_z}{\text{allow. } F_z} + \frac{F_y}{\text{allow. } F_y} + \frac{F_x}{\text{allow. } F_x} \leq 1$$

resp.

$$\frac{F_{z,\text{Ed}}}{F_{z,\text{Rd}}} + \frac{F_{y,\text{Ed}}}{F_{y,\text{Rd}}} + \frac{F_{x,\text{Ed}}}{F_{x,\text{Rd}}} \leq 1$$

F_x, F_y, F_z = existing load;
allow. F = allowable point-load capacity

resp.

$F_{x,\text{Ed}}, F_{y,\text{Ed}}, F_{z,\text{Ed}}$ = Design values of action

$F_{x,\text{Rd}}, F_{y,\text{Rd}}, F_{z,\text{Rd}}$ = Design values of resistance

① The bearing capacities are for loads acting on the front edge of the channel. For off-set transverse load (e.g. stand-off installations) the bending moment of the bolt must be considered and superimposed with the tensile load, see page 71.

HALFEN INDUSTRIAL TECHNOLOGY

Load Bearing Capacities for Welded or Bolted HALFEN Framing Channels

Cold-rolled framing channels with and without serrated lips

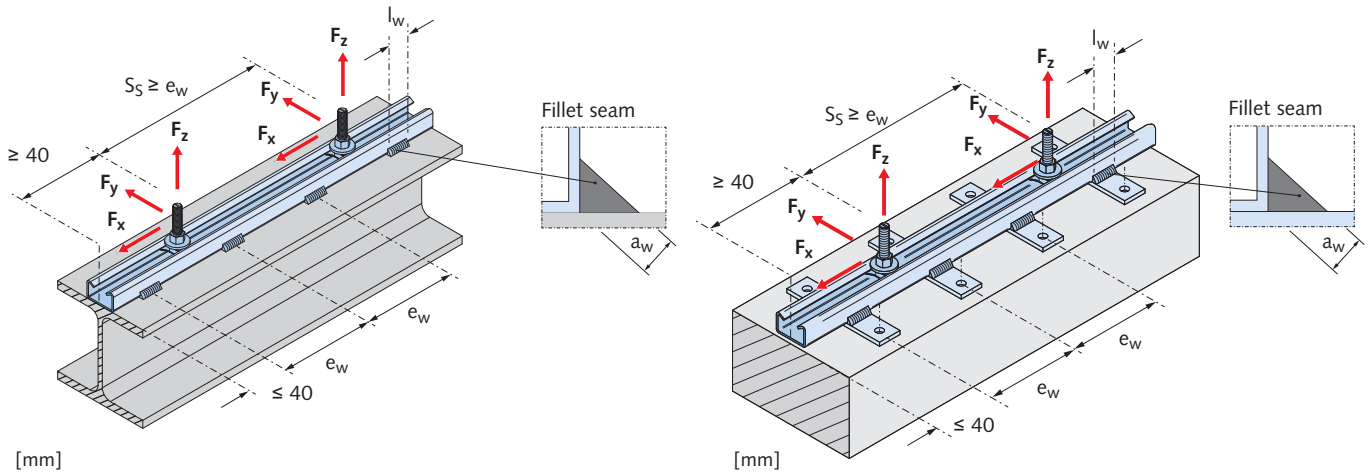

Load bearing capacities for welded or bolted cold-rolled framing channels

Cold-rolled profiles	Weld seams			Point-load bearing capacities ②				Longitudinal	
	a _w [mm]	l _w [mm]	e _w [mm]	Tension α ≤ 60° F _z [kN]		Shear γ < 60° F _y [kN]		allow. F _x	F _{x,Rd}
				allow. F _z	F _{z,Rd}	allow. F _y	F _{y,Rd}		
HM 50/40	3	30	400	5.4	7.6	1.9	2.7	①	①
HZM 41/41	3	30	300	5.6	7.8	1.2	1.7	5.0	7.0
HZM 41/22	3	30	120	5.6	7.8	1.5	2.1	5.0	7.0
HM 41/41	3	30	300	5.6	7.8	1.2	1.7	①	①
HM 41/22	3	30	120	5.6	7.8	1.5	2.1		
HM 36/36	3	30	300	4.4	6.2	1.2	1.7		
HM 38/17	3	30	100	4.8	6.7	2.5	3.5		
HM 28/15	3	30	100	2.5	3.5	1.2	1.7		

① Recommended load bearing capacities in channel longitudinal direction for standard (non-serrated) channels can be found on the respective product page

② The bearing capacities are for loads acting on the front edge of the channel. For off-set transverse load (e.g. stand-off installations) the bending moment of the bolt must be considered and superimposed with the tensile stress, see page 71.

HALFEN INDUSTRIAL TECHNOLOGY

HALFEN Bolts – Bending moments

Bending moments of HALFEN Bolts

Bending moments of HALFEN Bolts

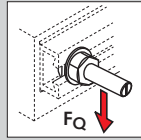

Recommended bolt bending moments from the front edge of the HALFEN Channel

Strength class

Thread ϕ	4.6		8.8		A2-50; A4-50		A2-70; A4-70	
	allow. M	M_{Rd} ①	allow. M	M_{Rd} ①	allow. M	M_{Rd} ①	allow. M	M_{Rd} ①
M6	2.0	2.8	-	-	1.8	2.5	3.8	5.3
M8	5.0	7.0	-	-	4.4	6.2	9.4	13.2
M10	10.0	14.0	24.9	34.9	8.7	12.2	18.7	26.2
M12	17.5	24.5	43.7②	61.2②	15.3	21.4	32.8②	45.9②
M16	44.4	62.2	111.0③	155.4③	38.8	54.3	83.3③	116.6③
M20	86.5	121.1	216.4	303.0	75.7	106.0	162.3	227.2
M24	149.7	209.4	374.2	524.0	131.1	183.3	156.2	218.7
M27	221.9	310.7	554.8	776.7	-	-	-	-
M30	299.9	419.9	-	-	-	-	-	-

① Recommended design value of bending moment capability for HALFEN Bolts

② For HM/HL 28/15 channels the bending moment must be reduced to $M_{Rd} = 42$ Nm resp. allow. M = 30 Nm

③ For HM/HL 38/17 channels the bending moment must be reduced to $M_{Rd} = 91$ Nm resp. allow. M = 65 Nm

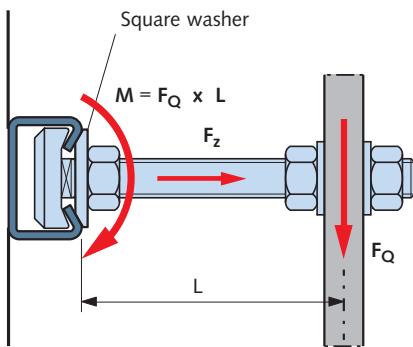

Always use square washers with stand-off installations.

In cases of bending with additional centric tension the action loads must be superimposed with the tensile load.



$$F_z \leq \text{allow. } F \cdot \left(1 - \frac{M}{\text{allow. } M}\right)$$

resp.

$$F_{z,Ed} \leq F_{Rd} \cdot \left(1 - \frac{M_{Ed}}{M_{Rd}}\right)$$

- F_z = existing tension load
- allow. F_z = allowable load bearing capacity of the bolt
- M = existing bending moment of the bolt
- allow. M = allowable bending moment of the bolt
- resp.
- $F_{z,Ed}$ = Design value for the existing tension load of the bolt
- $F_{z,Rd}$ = Design value for the resistance of the bolt
- M_{Ed} = Design value for the existing bending moment of the bolt
- M_{Rd} = Design value for bending moment resistance of the bolt

HALFEN INDUSTRIAL TECHNOLOGY

Framing Channels as Compression Elements

HALFEN Framing channels as compression element – hot-rolled

Buckling acc. to EN 1993-1-1
(Point-load applied at P)

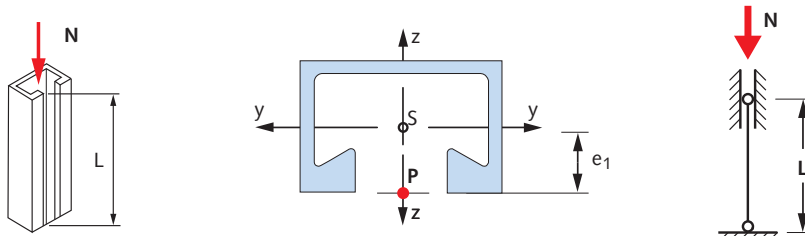

Table footnotes → see page 71

Hot-rolled channels – Load bearing capacities – buckling

Type	Cross section properties					N [kN] ①,② for profile lengths L [mm]										
	A [cm ²]	e ₁ [cm]	I _y [cm ⁴]	W _y [cm ³]	W _{pl} [cm ³]	500	1000	1500	2000	2500	3000	3500	4000	4500	5000	
HM 72/48	11.27	2.40	34.97	14.28	18.28	N _{Rd}	104.6	81.6	62.0	50.0	40.0	32.2	26.4	21.8	18.4	15.6
						allow. N	74.7	58.3	44.3	35.7	28.6	23.0	18.9	15.6	13.1	11.1
HM 55/42	8.61	2.21	18.75	8.49	11.73	N _{Rd}	79.0	57.5	43.0	32.8	25.1	19.8	15.8	12.9	10.7	9.0
						allow. N	56.4	41.1	30.7	23.4	17.9	14.1	11.3	9.2	7.6	6.4
HM 52/34	6.34	1.74	9.33	5.35	7.19	N _{Rd}	50.4	34.6	25.3	18.5	13.9	10.7	8.5	6.8	5.6	4.7
						allow. N	36.0	24.7	18.1	13.2	9.9	7.6	6.1	4.9	4.0	3.4
HM 50/30	4.15	1.63	5.26	3.23	4.38	N _{Rd}	31.8	21.4	15.3	11.0	8.2	6.3	4.9	4.0	3.2	2.7
						allow. N	22.7	15.3	10.9	7.9	5.8	4.5	3.5	2.8	2.3	1.9
HM 40/22	2.70	1.25	1.99	1.59	2.17	N _{Rd}	18.2	11.2	7.3	5.0	3.5	2.6	—	—	—	—
						allow. N	13.0	8.0	5.2	3.5	2.5	1.9	—	—	—	—
HM 72/48 D	22.54	4.85	205.15	42.30	55.20	N _{Rd}	195.2	169.2	148.0	128.0	110.0	98.0	87.0	77.0	68.5	61.0
						allow. N	139.4	120.9	105.7	91.4	78.6	70.0	62.1	55.0	48.9	43.6
HM 55/42 D	17.22	4.20	105.70	25.17	34.27	N _{Rd}	155.0	130.0	109.0	90.0	78.0	67.0	57.5	46.3	43.0	37.5
						allow. N	110.7	92.9	77.9	64.3	55.7	47.9	41.1	33.1	30.7	26.8
HM 52/34 D	12.70	3.35	51.49	15.37	20.42	N _{Rd}	97.0	80.0	64.5	53.5	45.0	37.5	31.8	26.9	23.1	20.0
						allow. N	69.3	57.1	46.1	38.2	32.1	26.8	22.7	19.2	16.5	14.3
HM 50/30 D	8.27	3.00	26.56	8.85	11.52	N _{Rd}	61.5	49.0	38.5	31.7	26.0	21.5	17.9	15.0	12.8	11.0
						allow. N	43.9	35.0	27.5	22.6	18.6	15.4	12.8	10.7	9.1	7.9
HM 40/22 D	5.33	2.30	10.06	4.38	5.73	N _{Rd}	37.0	27.5	20.9	16.1	12.6	10.0	8.1	6.7	5.6	4.7
						allow. N	26.4	19.6	14.9	11.5	9.0	7.1	5.8	4.8	4.0	3.4
HZM 64/44	9.10	2.30	23.83	10.36	13.66	N _{Rd}	91.0	68.0	51.0	39.5	30.5	24.3	19.5	16.0	13.3	11.2
						allow. N	65.0	48.6	36.4	28.2	21.8	17.4	13.9	11.4	9.5	8.0
HZM 53/34	5.88	1.86	9.19	4.95	6.80	N _{Rd}	51.8	35.0	25.5	18.5	13.9	10.6	8.4	6.8	5.6	4.7
						allow. N	37.0	25.0	18.2	13.2	9.9	7.6	6.0	4.8	4.0	3.3
HZM 41/27	4.31	1.51	3.90	2.57	3.74	N _{Rd}	31.5	20.0	13.2	9.2	6.7	5.0	3.9	3.1	2.5	—
						allow. N	22.5	14.3	9.4	6.6	4.8	3.6	2.8	2.2	1.8	—
HZM 38/23	3.10	1.33	2.11	1.59	2.31	N _{Rd}	20.7	12.5	7.9	5.3	3.8	2.8	2.2	—	—	—
						allow. N	14.8	8.9	5.6	3.8	2.7	2.0	1.6	—	—	—
HZM 29/20	1.99	1.12	1.02	0.91	1.31	N _{Rd}	12.5	7.1	4.3	2.8	—	—	—	—	—	—
						allow. N	8.9	5.1	3.1	2.0	—	—	—	—	—	—
HZM 64/44 D	18.21	4.40	127.94	29.08	38.23	N _{Rd}	171.0	144.5	122.0	102.0	88.5	76.5	66.0	57.5	50.0	43.9
						allow. N	122.1	103.2	87.1	72.9	63.2	54.6	47.1	41.1	35.7	31.4
HZM 53/34 D	11.75	3.40	46.38	13.64	18.14	N _{Rd}	100.0	81.0	63.5	53.0	43.5	36.3	30.3	25.5	21.7	18.8
						allow. N	71.4	57.9	45.4	37.9	31.1	25.9	21.6	18.2	15.5	13.4
HZM 41/27 D	8.62	2.70	19.91	7.37	10.22	N _{Rd}	65.5	49.5	38.0	29.8	23.5	18.9	15.3	12.7	10.6	9.0
						allow. N	46.8	35.4	27.1	21.3	16.8	13.5	10.9	9.1	7.6	6.4
HZM 38/23 D	6.19	2.30	10.04	4.36	6.00	N _{Rd}	43.6	30.9	23.4	17.5	13.5	10.6	8.5	6.9	5.8	4.9
						allow. N	31.1	22.1	16.7	12.5	9.6	7.6	6.1	4.9	4.1	3.5
HZM 29/20 D	3.97	2.00	5.12	2.56	3.49	N _{Rd}	27.9	19.1	13.8	10.0	7.6	5.9	4.6	3.8	3.1	2.6
						allow. N	19.9	13.6	9.9	7.1	5.4	4.2	3.3	2.7	2.2	1.8

HALFEN INDUSTRIAL TECHNOLOGY

Framing Channels as Compression Elements

HALFEN Framing channels as compression elements – cold-rolled

Flexural buckling acc to. EN 1993-1-1
(Point-load applied at P)

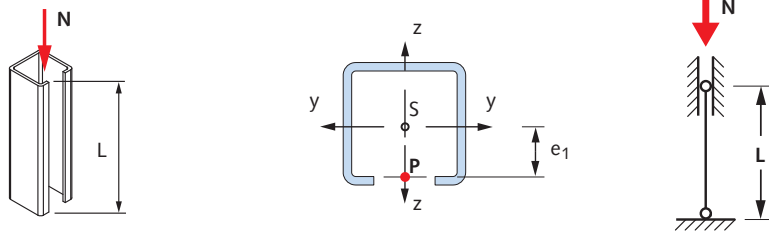

Cold-rolled channels – Load bearing capacities – buckling

Type	Cross-section properties					N [kN] ①,② for element length L [mm]										
	A [cm ²]	e ₁ [cm]	I _y [cm ⁴]	W _y [cm ³]	W _{pl} [cm ³]	500	1000	1500	2000	2500	3000	3500	4000	4500	5000	
	[kN]															
HM 50/40	4.26	2.18	8.64	3.96	5.53	N _{Rd}	33.2	24.6	18.5	14.2	11.1	8.8	7.0	5.8	4.8	4.1
						allow. N	23.7	17.6	13.2	10.1	7.9	6.3	5.0	4.1	3.5	2.9
HM 41/41	3.40	2.31	7.47	3.24	4.57	N _{Rd}	26.3	19.7	15.0	11.7	9.2	7.3	6.0	4.9	4.1	3.5
						allow. N	18.8	14.1	10.7	8.4	6.6	5.2	4.3	3.5	2.9	2.5
HM 36/36	2.80	2.07	4.54	2.19	3.19	N _{Rd}	19.7	14.1	10.6	8.0	6.1	4.8	3.9	3.2	2.6	2.2
						allow. N	14.1	10.1	7.5	5.7	4.4	3.4	2.8	2.3	1.9	1.6
HM 28/28	1.73	1.58	1.70	1.08	1.54	N _{Rd}	11.4	7.5	5.2	3.7	2.7	-	-	-	-	-
						allow. N	8.1	5.4	3.7	2.6	2.0	-	-	-	-	-
HZM 41/41	3.36	2.33	7.34	3.15	4.48	N _{Rd}	25.5	19.3	14.6	11.4	9.0	7.2	5.8	4.8	4.0	3.4
						allow. N	18.2	13.8	10.4	8.1	6.4	5.1	4.1	3.4	2.9	2.4
HZM 41/41 D	6.71	4.13	36.45	8.83	12.09	N _{Rd}	49.0	41.5	35.0	29.1	25.3	21.8	18.8	16.3	14.2	12.5
						allow. N	35.0	29.6	25.0	20.8	18.1	15.6	13.4	11.6	10.1	8.9
HL 50/40	3.73	1.95	7.14	3.65	4.68	N _{Rd}	31.5	22.8	16.9	12.8	9.8	7.7	6.1	5.0	4.1	3.5
						allow. N	22.5	16.3	12.1	9.1	7.0	5.5	4.4	3.6	2.9	2.5
HL 41/41	2.98	2.14	6.07	2.84	3.82	N _{Rd}	23.8	17.5	13.2	10.1	7.9	6.2	5.0	4.1	3.4	2.9
						allow. N	17.0	12.5	9.4	7.2	5.6	4.4	3.6	2.9	2.4	2.0
HL 36/36	2.42	1.85	3.65	1.97	2.64	N _{Rd}	18.3	12.7	9.4	7.0	5.3	4.1	3.2	2.6	-	-
						allow. N	13.1	9.1	6.7	5.0	3.8	2.9	2.3	1.9	-	-
HL 28/28	1.48	1.39	1.33	0.95	1.25	N _{Rd}	10.4	6.7	4.5	3.1	2.3	-	-	-	-	-
						allow. N	7.4	4.8	3.2	2.2	1.6	-	-	-	-	-
HZL 63/63 ③	7.09	3.01	33.07	10.06	13.51	N _{Rd}	65.0	53.2	43.3	35.4	29.7	24.8	20.9	17.7	15.2	13.1
						allow. N	46.4	38.0	30.9	25.3	21.2	17.7	14.9	12.6	10.9	9.4
HZL 41/41	2.90	2.18	5.87	2.69	3.70	N _{Rd}	22.5	16.7	12.6	9.7	7.5	6.0	4.8	4.0	3.3	2.8
						allow. N	16.1	11.9	9.0	6.9	5.4	4.3	3.4	2.8	2.3	2.0

① N_{Rd} = Design value of resistance
allow. N = allowable load

② allow. N = N_{Rd} / 1.4; E = 170 000 N/mm²

③ allow. N = N_{Rd} / 1.4; E = 210 000 N/mm²



NOTE:

For higher excentricity "e > e₁" a flexural buckling analysis according to Eurocode 3 is necessary

HALFEN INDUSTRIAL TECHNOLOGY

Applications in Mechanical and Plant Engineering

Information on dimensioning

When designing an adjustable assembly connection the external load F_i must be less or equal to the minimum allowable load of the HALFEN Bolt F_s and the maximum point-load capacity, i.e. the bending load capacity of the HALFEN Framing channel F_z .
 $F_i \leq \text{MIN} (F_{\text{Bolt}}; F_{\text{Channel}})$; $F_{\text{Channel}} \rightarrow$ see page 61 ff.

Design value of the resistance: $F_{R,d} = 1.4 \times F$ (Forces)

Design value of the moment resistance: $M_{R,d} = 1.4 \times M$ (Moments)

All following load specifications are allowable loads.

Symbols and definitions used in mechanical engineering – steel construction industry

1. Halfenschrauben

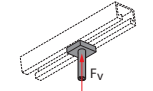
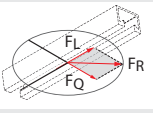
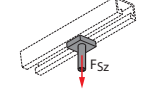
F_v		Preload, bolt The preload for the bolt occurs by applying a torque on the bolt and is calculated according to VDI 2230 guidelines.
F_R		Resulting load The resulting load F_R is the vector addition of the external loads F_L in the longitudinal channel direction and the external load F_Q transverse to the longitudinal channel direction; the resulting force is frictionally connected to the channel. $F_R = \sqrt{(F_L^2 + F_Q^2)}$
F_{sz}		Loads in the longitudinal bolt direction The load F_{sz} is an external load through the screws longitudinal axis, perpendicular to the channel surface and is transferred positive-locked to the channel.

Symbols and definitions used in mechanical engineering – steel construction industry

2. Framing channels

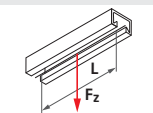
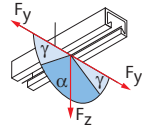
F_z		Maximum point-load-carrying capacity – centric load The load carrying capacity of the channel lips is decisive. Load figures are only valid for continuous welded channels or for intermittent welds according to the table on page 68 ff. In all other cases the suitability of the welding seam must be checked.
F_y		Load capacity of the channels under transverse load angle $\gamma < 60^\circ$ Allowable load for a defined angle to the welded or bolted channels.
F_z		Load capacity of the channels under transverse load angle $\alpha \leq 60^\circ$ Allowable load for a defined load angle to the welded or bolted channels.

The load F_{sz} along the screw longitudinal axis must be less or equal to the maximum point-load capacity of the framing channel F_z .

$$F_{sz} \leq F_z$$

The load F_Q transverse to the longitudinal channel direction must be less or equal to the load capacity transverse to the longitudinal channel direction of the framing channel F_y .

$$F_Q \leq F_y$$

HALFEN INDUSTRIAL TECHNOLOGY

Applications in Mechanical and Plant Engineering

Required bolt length L_{bolt}

The required bolt length L_{bolt} is the sum of the clamp thickness KD and the minimum required supplement L_{sup} .

$$L_{bolt} = KD + L_{sup}$$

$$L_{sup} = h + m + v$$

The thread protrusion v has to extend above the nut at least $0.5 \times$ the nut height m (DIN EN 24032, regulation for nuts).

Minimum required supplement L_{sup}
according to the table below

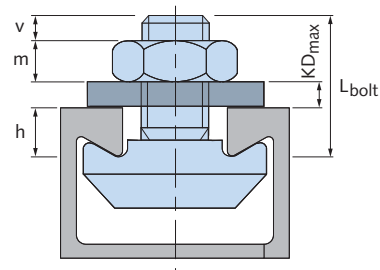

Minimum required supplement for HALFEN Bolts (heavy duty framing systems) [mm]

Thread	HM 72/48	HM 55/42	HM 52/34	HM 50/30	HM 49/30	HM 40/22	HM 40/25	HM 422	HZM 64/44	HZM 53/34	HZM 41/27	HZM 38/23	HZM 29/20	HM 50/40	HM 486
M6	-	-	-	-	-	-	-	-	-	-	-	-	-	-	-
M8	-	-	-	-	-	-	-	-	-	-	-	-	12	-	-
M10	-	25	24	20	20	18	18	18	-	-	18	17	15	-	-
M12	-	29	27	24	23	22	22	22	-	-	21	21	16	19	18
M16	-	35	33	30	29	28	28	28	-	28	27	27	20	23	22
M20	42	39	38	34	34	-	-	-	34	32	-	-	-	29	28
M24	47	-	-	-	-	-	-	-	40	-	-	-	-	33	32
M27	50	-	-	-	-	-	-	-	-	-	-	-	-	-	-
M30	53	-	-	-	-	-	-	-	-	-	-	-	-	-	-

Minimum required supplement for HALFEN Bolts (medium duty framing systems) [mm]

Thread	HZL 63/63	HM 41/41	HM 41/22	HM 41/62	HM 41/83
M6	-	-	-	-	-
M8	-	18	18	18	18
M10	-	19	19	19	19
M12	19	23	23	23	23
M16	23	29	29	29	29
M20	29	-	-	-	-
M24	33	-	-	-	-

Minimum required supplement for HALFEN Bolts (light duty framing systems) [mm]

Thread	HM 36/36	HM 38/17	HM 28/28	HM 26/26	HM 28/15	HM 315	HM 20/12
M6	-	-	-	-	-	-	-
M8	-	-	10	9	10	9	9
M10	15	15	13	12	13	12	12
M12	18	19	14	13	14	14	-
M16	24	25	18	17	18	17	-

HALFEN INDUSTRIAL TECHNOLOGY

Applications in Mechanical and Plant Engineering

Static and dynamic tension tests

The transferability of static and dynamic loads for adjustable assembly systems was intensely studied in cooperation with the State Material Testing Institute at the TU Darmstadt (Technical University Darmstadt).

Following VDI guideline 2230, the data acquired from bolt tightening tests, static and dynamic traction tests form the basis of algorithms used for calculating adjustable assembly systems.

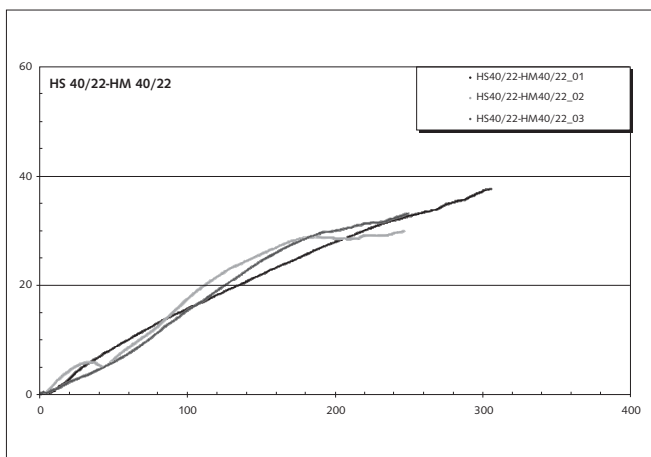

Graph: tightening test results

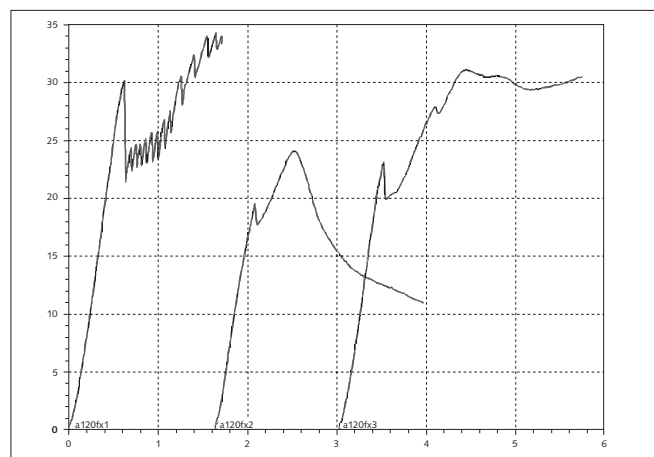

Graph: tension test results



Tightening test



Tension test



Fatigue test

HALFEN INDUSTRIAL TECHNOLOGY

Applications in Mechanical and Plant Engineering

Generating the preload force F_V

During assembly of bolt connections the torque M_A induces a preload force F_V in the bolt, which clamps the component to the framing channel. The preload force F_V depends on the torque M_A , the friction coefficients μ_G of the bolt thread and μ_K on the nut contact surface.

The preload forces for stainless steel bolts 50/70 and for HALFEN Bolts in steel, strength class 4.6 and 8.8 are specified in the following tables (ref. Rohloff-Matek).

The data listed for the torque M_A are recommended values. Standard delivery condition for HALFEN Bolts is non-lubricated, installation ready.

The friction coefficients μ_G and μ_K are 0.24.

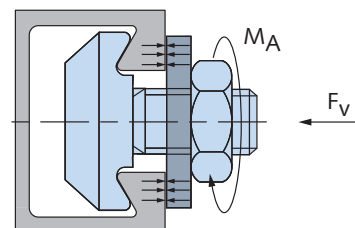

Preload force F_V , strength class 4.6 [kN]

	M_A [Nm]	Friction coefficient $\mu_G = \mu_K$												
		0.12	0.14	0.16	0.18	0.20	0.22	0.24	0.26	0.28	0.30	0.32	0.34	0.36
M6	3	3.0	2.6	2.3	2.1	1.9	1.8	1.6	1.5	1.4	1.3	1.2	1.2	1.1
M8	8	6.1	5.3	4.7	4.3	3.9	3.5	3.3	3.0	2.8	2.7	2.5	2.4	2.2
M10	15	9.2	8.0	7.1	6.4	5.8	5.3	4.9	4.6	4.3	4.0	3.8	3.6	3.4
M12	25	12.9	11.3	10.0	9.0	8.2	7.5	6.9	6.4	6.0	5.6	5.3	5.0	4.7
M16	65	25.6	22.3	19.8	17.8	16.1	14.8	13.6	12.6	11.8	11.0	10.4	9.8	9.2
M20	130	40.8	35.6	31.6	28.4	25.7	23.6	21.7	20.1	18.8	17.6	16.5	15.6	14.8
M24	230	60.5	52.8	46.8	42.0	38.2	34.9	32.2	29.9	27.8	26.1	24.5	23.1	21.9
M27	340	79.8	69.5	61.5	55.2	50.0	45.8	42.1	39.1	36.4	34.1	32.0	30.2	28.6
M30	460	96.7	84.2	74.6	67.0	60.7	55.6	51.2	47.5	44.2	41.4	38.9	36.7	34.8

Preload force F_V , strength class 8.8 [kN]

	M_A [Nm]	Friction coefficient $\mu_G = \mu_K$												
		0.12	0.14	0.16	0.18	0.20	0.22	0.24	0.26	0.28	0.30	0.32	0.34	0.36
M8	20	15.2	13.3	11.8	10.6	9.7	8.9	8.2	7.6	7.1	6.6	6.2	5.9	5.6
M10	40	24.4	21.4	19.0	17.1	15.5	14.2	13.1	12.2	11.4	10.7	10.0	9.5	9.0
M12	70	36.1	31.6	28.1	25.2	22.9	21.0	19.4	18.0	16.8	15.7	14.8	14.0	13.2
M16	180	70.8	61.8	54.8	49.2	44.6	40.9	37.7	34.9	32.6	30.5	28.7	27.1	25.6
M20	360	113.1	98.6	87.5	78.5	71.3	65.2	60.1	55.8	52.0	48.7	45.8	43.2	40.9
M24	620	163.1	142.3	126.2	113.3	102.8	94.1	86.8	80.5	75.0	70.3	66.1	62.3	59.0
M27	900	211.2	183.9	162.8	146.1	132.5	121.1	111.6	103.5	96.4	90.2	84.8	80.0	75.7
M30	1200	252.1	219.7	194.7	174.7	158.5	145.0	133.6	123.8	115.4	108.1	101.6	95.8	90.7

Preload force F_V , strength class 50

	M_A [Nm]	Friction coefficient $\mu_G = \mu_K$												
		0.12	0.14	0.16	0.18	0.20	0.22	0.24	0.26	0.28	0.30	0.32	0.34	0.36
M6	3	3.0	2.6	2.3	2.1	1.9	1.8	1.6	1.5	1.4	1.3	1.2	1.2	1.1
M8	7	5.3	4.6	4.1	3.7	3.4	3.1	2.9	2.7	2.5	2.3	2.2	2.1	2.0
M10	14	8.6	7.5	6.7	6.0	5.4	5.0	4.6	4.3	4.0	3.7	3.5	3.3	3.1
M12	25	12.9	11.3	10.0	9.0	8.2	7.5	6.9	6.4	6.0	5.6	5.3	5.0	4.7
M16	60	23.6	20.6	18.3	16.4	14.9	13.6	12.6	11.6	10.9	10.2	9.6	9.0	8.5
M20	120	37.7	32.9	29.2	26.2	23.8	21.7	20.0	18.6	17.3	16.2	15.3	14.4	13.6
M24	200	52.6	45.9	40.7	36.6	33.2	30.4	28.0	26.0	24.2	22.7	21.3	20.1	19.0

Preload force F_V , strength class 70

	M_A [Nm]	Friction coefficient $\mu_G = \mu_K$												
		0.12	0.14	0.16	0.18	0.20	0.22	0.24	0.26	0.28	0.30	0.32	0.34	0.36
M6	7	7.0	6.2	5.5	4.9	4.5	4.1	3.8	3.5	3.3	3.1	2.9	2.7	2.6
M8	15	11.4	10.0	8.9	8.0	7.2	6.6	6.1	5.7	5.3	5.0	4.7	4.4	4.2
M10	30	18.3	16.0	14.3	12.8	11.7	10.7	9.9	9.2	8.5	8.0	7.5	7.1	6.7
M12	50	25.8	22.6	20.0	18.0	16.4	15.0	13.8	12.9	12.0	11.2	10.6	10.0	9.4
M16	125	49.2	42.9	38.0	34.2	31.0	28.4	26.2	24.3	22.6	21.2	19.9	18.8	17.8
M20	245	76.9	67.1	59.5	53.5	48.5	44.4	40.9	38.0	35.4	33.1	31.2	29.4	27.8
M24	420	110.5	96.4	85.5	76.8	69.7	63.8	58.8	54.5	50.8	47.6	44.8	42.2	40.0

HALFEN INDUSTRIAL TECHNOLOGY

Applications in Mechanical and Plant Engineering

Transfer of static loads

External loads F_L , F_Q and F_{S_z} acting on the building component are transferred to the bolt connection by clamping.

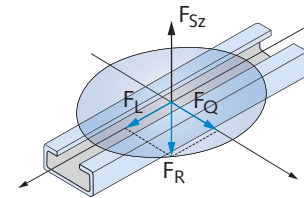

Force F_{S_z} acts positively in the bolt longitudinal axis.

Force F_L acting in and F_Q acting transverse to the longitudinal channel direction are transferred frictionally through the component-channel surface and are added to the resulting force F_R :

$$F_R = \sqrt{F_L^2 + F_Q^2}$$

Transfer of the friction force F_R requires a normal force F_N acting in the bolt longitudinal axis:

$$F_N = \frac{F_R}{\mu_T}$$

The minimum required clamping force $F_{K,req}$ is a result of the two forces F_N and F_{S_z} acting in the bolt longitudinal axis:

$$F_{K,req} = F_N + F_{S_z} = \frac{F_R}{\mu_T} + F_{S_z}$$

When designing the bolt connection the bolt tightening procedure and the bolt setting behavior must be considered in accordance with VDI guideline 2230. The setting factor S_{set} is intended as a safety factor as the setting force loss for adjustable bolt connections is difficult to calculate using VDI 2230.

Therefore the minimum necessary assembly preloading strength $F_{M, min}$ is:

$$F_{M, min} = S_{set} \times F_{K, req}$$

Taking the bolt tightening procedure into consideration with the tightening factor α_A the maximum necessary assembly preloading force $F_{M, max}$ calculates at:

$$F_{M, max} = \alpha_A \times F_{M, min} = \alpha_A \times S_{set} \times \left(\frac{F_R}{\mu_T} + F_{S_z} \right)$$

The maximum required assembly preloading force $F_{M, max}$ must be smaller than the preloading force F_V produced by the bolt tightening procedure moment M_A :

$$F_{M, max} \leq F_V$$

The allowable loads for channel assembly systems are shown for **delivery condition** ($\mu_G = \mu_K = 0.24$) and for **lubricated bolts** ($\mu_G = \mu_K = 0.14$) in the tables on page 79.

The values for F_R apply only to transverse force requirements ($F_{S_z} = 0$), the values for F_{S_z} for pure traction force requirement ($F_R = 0$).

When overlaying the transverse force F_R and longitudinal force F_{S_z} apply the formulas listed right for the maximum assembly preloading force $F_{M, max}$.

HALFEN INDUSTRIAL TECHNOLOGY

Applications in Mechanical and Plant Engineering

Allowable Loads

Allowable loads F_R and F_{S_z} - channel bolt connection								
Strength class 4.6								
Thread	M_A [Nm]	Delivery condition $\mu_G = \mu_K = 0.24$			Lubricated $\mu_G = \mu_K = 0.14$			
		F_V [kN]	F_R [kN]	F_Z [kN]	F_V [kN]	F_R [kN]	F_Z [kN]	
M6	3	1.6	0.2	0.7	2.6	0.3	1.1	
M8	8	3.3	0.3	1.4	5.3	0.6	2.2	
M10	15	4.9	0.5	2.1	8.0	0.8	3.3	
M12	25	6.9	0.7	2.9	11.3	1.2	4.7	
M16	65	13.6	1.4	5.7	22.3	2.3	9.3	
M20	130	21.7	2.3	9.0	35.6	3.7	14.8	
M24	230	32.2	3.4	13.4	52.8	5.5	22.0	
M27	340	42.1	4.4	17.6	69.5	7.2	28.9	
M30	460	51.2	5.3	21.3	84.2	8.8	35.1	

Allowable loads F_R and F_{S_z} - channel bolt connection								
Strength class 8.8								
Thread	M_A [Nm]	Delivery condition $\mu_G = \mu_K = 0.24$			Lubricated $\mu_G = \mu_K = 0.14$			
		F_V [kN]	F_R [kN]	F_Z [kN]	F_V [kN]	F_R [kN]	F_Z [kN]	
M10	40	13.1	1.4	5.5	21.4	2.2	8.9	
M12	70	19.4	2.0	8.1	31.6	3.3	13.2	
M16	180	37.7	3.9	15.7	61.8	6.4	25.7	
M20	360	60.1	6.3	25.1	98.6	10.3	41.1	
M24	620	86.8	9.0	36.2	142.3	14.8	59.3	
M27	900	111.6	11.6	46.5	183.9	19.2	76.6	

Allowable loads F_R and F_{S_z} - channel bolt connection								
Strength class 50								
Thread	M_A [Nm]	Delivery condition $\mu_G = \mu_K = 0.24$			Lubricated $\mu_G = \mu_K = 0.14$			
		F_V [kN]	F_R [kN]	F_Z [kN]	F_V [kN]	F_R [kN]	F_Z [kN]	
M8	7	2.9	0.3	1.4	4.6	0.6	2.2	
M10	14	4.6	0.5	2.1	7.5	0.8	3.4	
M12	25	6.9	0.7	2.9	11.3	1.2	4.7	
M16	60	12.6	1.3	5.3	20.6	2.2	8.6	
M20	120	20.0	2.1	8.4	32.9	3.4	13.8	
M24	200	28.0	2.9	11.7	45.9	4.8	19.2	

Allowable loads F_R and F_{S_z} - channel bolt connection								
Strength class 70								
Thread	M_A [Nm]	Delivery condition $\mu_G = \mu_K = 0.24$			Lubricated $\mu_G = \mu_K = 0.14$			
		F_V [kN]	F_R [kN]	F_Z [kN]	F_V [kN]	F_R [kN]	F_Z [kN]	
M8	15	6.1	0.6	2.6	10.0	1.0	4.2	
M10	30	9.9	1.0	4.1	16.0	1.7	6.7	
M12	50	13.8	1.4	5.8	22.6	2.4	9.4	
M16	125	26.2	2.7	10.9	42.9	4.5	17.9	
M20	245	40.9	4.3	17.1	67.1	7.0	28.0	
M24	420	58.8	6.1	24.5	96.4	10.0	40.2	

The provided data is based on the following failure modes and values:

Failure mode for transverse force load	F_R : component slippage
Failure mode for longitudinal force load	F_{S_z} : component separation
Friction coefficient in connection:	$\mu_T = 0.25$
Tightening factor (electrical-audible torque wrench):	$\alpha_A = 2.0$
Safety factor setting of bolt connection:	$S_{set} = 1.2$

The force F_Q transverse to the longitudinal channel direction must be smaller or equal to the load capacity transverse to the longitudinal channel direction of the HALFEN Framing channel F_y (→ see table on page 66).

$$F_Q \leq F_y$$

The force in the longitudinal bolt direction F_{S_z} must be smaller or equal to the maximum point-load capacity of the HALFEN Framing channel F_z (→ see table on page 66).

$$F_{S_z} \leq F_z$$

HALFEN INDUSTRIAL TECHNOLOGY

Applications in Mechanical and Plant Engineering

Point-load capacities for HALFEN Framing channels

For welded and dowel-fixed HALFEN Framing channels

Point-load capacities for hot-rolled, framing channels

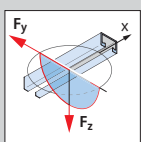

hot-rolled channels	allow. F_z [kN]	allow. F_y [kN]
HM 72/48	47.6	19.8
HM 55/42	39.7	17.9
HM 52/34	27.0	15.1
HM 50/30	15.1	10.7
HM 40/22	10.3	5.6
HZM 64/44	38.1	12.5
HZM 53/34	30.9	9.3
HZM 41/27	17.8	4.4
HZM 38/23	12.8	4.2
HZM 29/20	8.0	1.5

Observe the notes in the table on page 68 – 69!

Point-load capacities for cold-rolled, framing channels

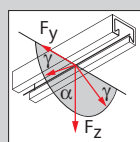

cold-rolled channels	tension $\alpha \leq 60^\circ$ allow. F_z [kN]	transverse tension $\gamma < 60^\circ$ allow. F_y [kN]
HM 50/40	5.4	1.9
HZM 41/41	5.6	1.2
HZM 41/22	5.6	1.5
HM 41/41	5.6	1.2
HM 41/22	5.6	1.5
HM 36/36	4.4	1.2
HM 38/17	4.8	2.5
HM 28/15	2.5	1.2
-	-	-
-	-	-

Observe the notes in the table on page 70 !

Example:

Specified: external load in longitudinal channel direction
external load transverse to the longitudinal channel direction
external load in longitudinal bolt direction
friction between component – channel
setting factor
tightening factor

$$F_L = 1.5 \text{ kN}$$

$$F_Q = 0.5 \text{ kN}$$

$$F_{S_z} = 2.0 \text{ kN}$$

$$\mu_T = 0.25$$

$$S_{set} = 1.2$$

$$\alpha_A = 2$$

Selected framing channel HM 50/30

Resulting load F_R 1.58 kN

Minimum required assembly preloading force $F_{M \min}$ 10 kN

Maximum required assembly preloading force $F_{M \max}$ 20 kN

Selected HALFEN Bolt 50/30, 4.6 in delivery condition M 20

Preloading F_V 21.7 kN

Comparison of external loads with permissible load of channel HM 50/30 with values in table above

$$F_z = 15.1 \text{ kN} > F_{S_z} \quad \checkmark$$

$$F_y = 10.7 \text{ kN} > F_Q \quad \checkmark$$

Result:

Selected framing channel: HM 50/30

Selected HALFEN Bolt: HS 50/30 – M20 - scl. 4.6 in standard delivery condition

HALFEN INDUSTRIAL TECHNOLOGY

Applications in Mechanical and Plant Engineering

Transfer of dynamic loads

Hot-rolled assembly channels are suitable for the transfer of dynamic loads when used in conjunction with nibbed HALFEN Bolts (type HSR) or serrated HALFEN Bolts (type HZS).

The dynamic load $F_{L\ dyn}$ acting on the building component in the longitudinal channel direction, is frictionally transferred via the channel/bolt contact surface to the channel.

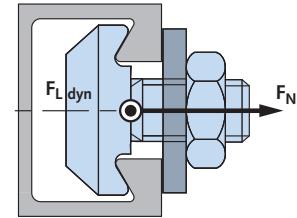

A clamping force $F_{K\ req}$ acting in the bolt longitudinal axis is necessary for friction transfer $F_{L\ dyn}$:

$$F_{K\ req} = \frac{F_{L\ dyn}}{\mu_T}$$

According to VDI guideline 2230 when designing the bolt connection, the bolt tightening procedure and the bolt setting behaviour must be considered.

The setting factor S_{set} is intended as a safety factor as the setting force loss for adjustable bolt connections is difficult to calculate using VDI 2230.

$$F_{M\ min} = S_{Set} \times F_{K\ erf}$$

Therefore the minimum necessary assembly preload strength $F_{M\ min}$ is:

Taking the bolt tightening procedure into consideration with the tightening factor α_A the maximum necessary assembly preload force $F_{M\ max}$ is calculated at:

$$F_{M\ max} = \alpha_A \times S_{Set} \times \frac{F_{L\ dyn}}{\mu_T}$$

The calculated maximum assembly preload force $F_{M\ max}$ must be smaller or equal to the preload force F_V of the bolt (see table):

$$F_{M\ max} \leq F_V$$

The permissible dynamic loads for channel assembly systems are shown as for **delivery condition** ($\mu_G = \mu_K = 0.24$) and for a lubricated condition ($\mu_G = \mu_K = 0.14$) in the following table.

The values are valid for **pure alternating stress with a transverse force in the longitudinal channel direction**.

The stress ratio is $R = -1$ and the maximum load changes value is $N = 10^6$.

Allowable dynamic loads $F_{L\ dyn}$ – channel-bolt connection							
HALFEN Bolts HSR and HZS, strength class 8.8							
		Delivery condition			Lubricated		
		$\mu_G = \mu_K = 0.24$			$\mu_G = \mu_K = 0.14$		
Thread	M_A [Nm]	F_V [kN]	$F_{L\ dyn}$ [kN]	Typ	F_V [kN]	$F_{L\ dyn}$ [kN]	Type
M12	80	22.3	2.3	HZS	36.2	3.8	HZS
M16	120	25.2	2.6	HZS	41.3	4.3	HZS
M16	200	42.1	4.4	HSR	68.8	7.2	HSR
M20	400	67.2	7.0	HSR	109.9	11.4	HSR

This data is based on the following failure modes and values:

Failure mode for transverse force load $F_{L\ dyn}$: component slippage
 Friction coefficient in connection: $\mu_T = 0.25$
 Tightening factor (electrical-audible torque wrench): $\alpha_A = 2.0$
 Safety factor setting of bolt joint: $S_{set} = 1.2$

Individual calculation of bolted connections is achieved using the formulas and tables listed above.

HALFEN INDUSTRIAL TECHNOLOGY

Tender texts

Invitation to tender – examples for HALFEN Framing channels and cantilevers

HALFEN FRAMING CHANNELS HM 52/34 - WB - 6070

HALFEN – Framing channel, HM 52/34 hot-rolled channel, with CE marking in accordance with ETA 19/0438

Material: (WB) Mill finish steel, delivered in 6.07 metre units, cut to specified length and installed. For adjustable connections in support structures using system compliant HALFEN Bolts.

Observe the manufacturer's instructions for installation and application.

Nominal channel dimensions (width × height): 52 mm × 34 mm

Length (mm):

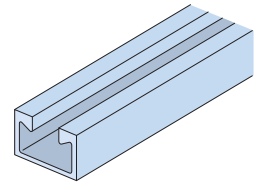

HALFEN FRAMING CHANNEL HM 50/30 - FV - 6070

HALFEN – Framing channel HM 50/30 hot-rolled galvanized, with CE marking in accordance with ETA 19/0438.

Material: WB Mill finish steel, delivered in 6.07 metre units, cut to specified length and installed. For adjustable connections in support structures using system compliant HALFEN Bolts.

Observe the manufacturer's instructions for installation and application.

Nominal channel dimensions (width × height): 50 mm × 30 mm

Length (mm):

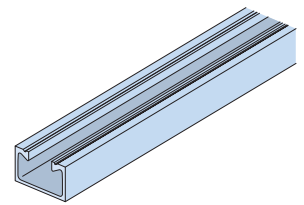

HALFEN FRAMING CHANNEL HZM 53/34 - A4 - 6070

HALFEN – Framing channel HZM 53/34 channel, hot-rolled and serrated, A4, with CE marking in accordance with DIN EN 1090.

Material: (A4) stainless steel, 1.4571/1.4404, delivered in approx. 6.07 metre units, cut to specified length and installed. For adjustable connections in support structures using system compliant serrated HALFEN Bolts.

Observe the manufacturer's instructions for installation and application.

Nominal channel dimensions (width × height): 53 mm × 34 mm

Length (mm):

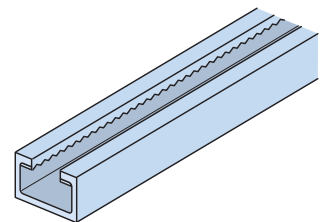

HALFEN Cantilever KON 36/2, hot-dip galvanized

HALFEN – Cantilever, KON 36/2, hot-dip galvanized (FV), with CE marking in accordance with DIN EN 1090, For adjustable connection in support structures using system compliant HALFEN Bolts.

Required cantilever length according to on-site specifications.

Length (mm):

Deliver and install.

Observe the manufacturer's instructions for installation and application.

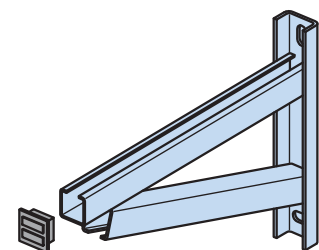

Further tender specifications at: [www.halfen.com/Service/Tender texts](http://www.halfen.com/Service/Tender%20texts)

HALFEN INDUSTRIAL TECHNOLOGY

The Innovation in Pipeline Construction

The multi-functional system for any project

POWERCLICK SYSTEM 63



Suitable for pipes with nominal diameters up to DN 150 mm or with separate verification up to 400 mm
→ Catalogue PC 63

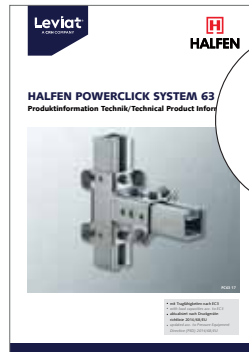

TESTED
ACC. TO EN 13480
(TYPE TESTING)
BY TÜV
POWERCLICK
SYSTEM 63

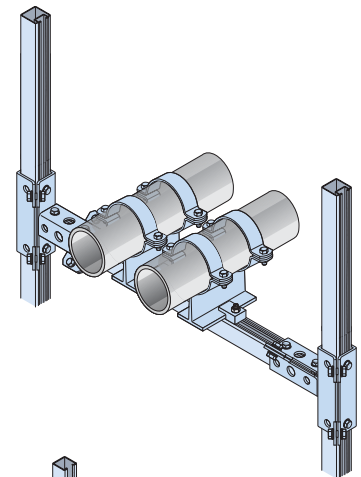

POWERCLICK SYSTEM 41



Suitable for pipes with nominal diameters up to DN 80 mm or with separate verification for up to DN 150 mm with short spans sizes
→ Catalogue PC 41

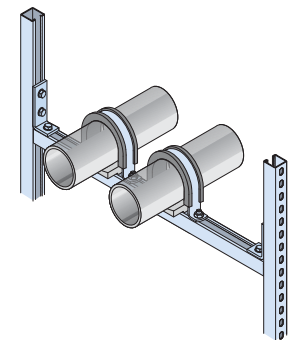
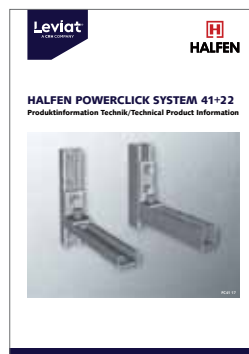

POWERCLICK SYSTEM 22



Suitable for pipes with nominal diameters up to DN 25 mm
→ Catalogue PC 41

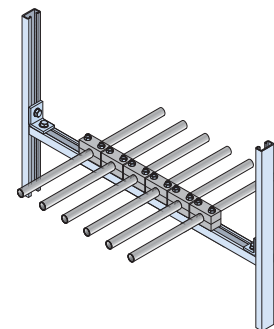

POWERCLICK ACCESSORIES

Cantilever brackets, pipe clamps, sliding supports
→ Catalogue PC Z



Product information on the internet.
Catalogues and tender texts available at:
www.halfen.com/Products/Powerclick.
Or scan the code, select the required document and download the PDF.



HALFEN INDUSTRIAL TECHNOLOGY

Index

Product/keyword	Page
Accessories	54-59
Adjustment coupler HJV	59
Bending load bearing capacities - framing channels	62-67
Bending moments HALFEN Bolts	71
Bolt length - calculation of	10
Bolts	9, 56-57
Cantilevers KON	61
Cap for channel ends HPE	55
CE marking	6
Channel cover PA	55
Channel end cap	55
Compression elements	72-73
Coupler sleeves VBM, SKM	59
Coupler sleeves with right-hand left-hand thread	59
Dynamic loads	76
European standards	6
Flexural buckling - framing channels	72-73
Framing channels - type overview	8, 14-15
-non slotted HM, HZM hot-rolled	62-63
-non slotted HM, HZM cold-rolled	64-65
-with slot hole HL, HZL	66-67
Geometry - slot holes and spacings	66
HALFEN Bolts type HS, HZS, HSR	9
HALFEN Cast-in channels for installation in concrete	7
HALFEN Framing channels - product overview	14-15
Hexagonal Bolts HSK	59
Hexagonal coupler sleeves	59
Hexagonal nuts MU	58

Product/keyword	Page
Load capacities - framing channels	62-65
Locking plates	10
Locking washers SIC	58
Materials	12-13
Nuts MU	58
Ordering examples	10
Point-load capacity	68-70
Powerclick	41-83
Preloading force	77
Product range - Framing channels	14-15
Product range - HALFEN Bolts	56-57
Ring nuts RM	59
Serrated cast in channels	7
Square washer VUS	58
Stainless steel profiles - overview	14-15
Stand-off installation	71
Tender texts	82
Threaded rods GWS	59
Toothed channels = serrated channels	8, 14-15
Turnbuckles with right- and left-hand sleeves	59
Verification method - explanation	6
Washers	58





Leviat®

Innovative engineered products
and construction solutions that
allow the industry to build safer,
stronger and faster.

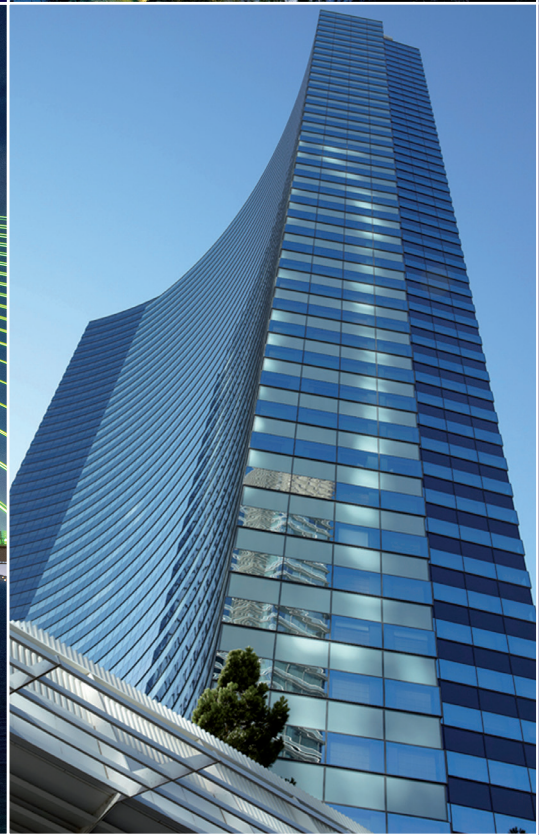

Contact Leviat worldwide

Australia

Unit A, 1 Heinrich Close,
Eastern Creek, Sydney, NSW 2766
Tel: +61 - 2 8808 3100
Email: info.au@leviat.com

Austria

Leonard-Bernstein-Str. 10
Saturn Tower, 1220 Wien
Tel: +43 - 1 - 259 6770
Email: info.at@leviat.com

Belgium

Industrielaan 2
1740 Ternat
Tel: +32 - 2 - 582 29 45
Email: info.be@leviat.com

China

Room 601 Tower D,
Vantone Centre
No. A6 Chao Yang Men Wai Street
Chaoyang District
Beijing P.R. China 100020
Tel: +86 - 10 5907 3200
Email: info.cn@leviat.com

Czech Republic

Pekařská 695/10a
155 00 Praha 5
Tel: +420 - 311 - 690 060
Email: info.cz@leviat.com

Finland

Vädursgatan 5
412 50 Göteborg / Sweden
Tel: +358 (0)10 6338781
Email: info.fi@leviat.com

France

6, Rue de Cabanis
31240 L'Union
Tel: +33 (0)5 34 25 54 82
Email: info.fr@leviat.com

Germany

Liebigstrasse 14
40764 Langenfeld
Tel: +49 - 2173 - 970 - 0
Email: info.de@leviat.com

India

Unit S4, 902, A Wing,
Lodha iThink Techno Campus Building,
Panchpakhadi, Pokharan Road 2,
Thane, 400606
Tel: +91-022 695 33700
Email: info.in@leviat.com

Italy

Via F.lli Bronzetti 28
24124 Bergamo
Tel: +39 - 035 - 0760711
Email: info.it@leviat.com

Malaysia

28 Jalan Anggerik Mokara 31/59
Kota Kemuning,
40460 Shah Alam Selangor
Tel: +603 - 5122 4182
Email: info.my@leviat.com

Netherlands

Oostermaat 3
7623 CS Borne
Tel: +31 - 74 - 267 14 49
Email: info.nl@leviat.com

New Zealand

246D James Fletcher Drive, Otahuhu,
Auckland 2024
Tel: +64 - 9 276 2236
Email: info.nz@leviat.com

Philippines

27F Office A, Podium West Tower,
12 ADB Avenue, Ortigas Center
Mandaluyong City, 1550
Tel: +63 - 2 7957 6381
Email: info.ph@leviat.com

Poland

Ul. Obornicka 287
60-691 Poznań
Tel: +48 - 61 - 622 14 14
Email: info.pl@leviat.com

Singapore

10 Benoi Sector,
Singapore 629845
Tel: +65 - 6266 6802
Email: info.sg@leviat.com

Spain

Polígono Industrial Santa Ana
c/ Ignacio Zuloaga, 20
28522 Rivas-Vaciamadrid
Tel: +34 - 91 632 18 40
Email: info.es@leviat.com

Sweden

Vädursgatan 5
412 50 Göteborg
Tel: +46 - 31 - 98 58 00
Email: info.se@leviat.com

Switzerland

Grenzstrasse 24
3250 Lyss
Tel: +41 (0)800 22 66 00
Email: info.ch@leviat.com

United Arab Emirates

RA08 TB02, PO Box 17225
JAFZA, Jebel Ali, Dubai
Tel: +971 (0)4 883 4346
Email: info.ae@leviat.com

United Kingdom

President Way,
President Park,
Sheffield S4 7UR
Tel: +44 - 114 275 5224
Email: info.uk@leviat.com

USA / Canada

6467 S Falkenburg Road
Riverview, FL 33578
Tel: (800) 423-9140
Email: info.us@leviat.us

For countries not listed

Email: info@leviat.com

Notes regarding this document

© Protected by copyright. The information in this publication is based on state-of-the-art technology at the time of publication. In every case, project working details should be entrusted to appropriately qualified and experienced persons. Leviat shall not accept liability for the accuracy of the information in this document or for any printing errors. We reserve the right to make technical and design changes at any time. With a policy of continuous product development, Leviat reserves the right to modify product design and specification at any time.

Leviat®

Imagine. Model. Make.

Leviat.com